

# DATA SHEET

## **TDA9815**

**Multistandard/MAC VIF-PLL with  
QSS-IF and dual FM-PLL/AM  
demodulator**

Product specification  
Supersedes data of 1995 Oct 03  
File under Integrated Circuits, IC02

1998 Feb 11

**Multistandard/MAC VIF-PLL with QSS-IF  
and dual FM-PLL/AM demodulator**

**TDA9815**

**FEATURES**

- 5 V supply voltage
- Two switched VIF inputs, gain controlled wide band VIF-amplifier (AC-coupled)
- True synchronous demodulation with active carrier regeneration (very linear demodulation, good intermodulation figures, reduced harmonics, excellent pulse response)
- Robustness for over-modulation better than 105% due to gated phase detector at L/L accent standard
- VCO frequency switchable between L and L accent (alignment external) picture carrier frequency
- Separate video amplifier for sound trap buffering with high video bandwidth
- VIF-AGC detector for gain control, operating as peak sync detector for B/G, peak white detector for L and peak level for MAC (optional external AGC); signal controlled reaction time for L and MAC
- Tuner AGC with adjustable takeover point (TOP)
- AFC detector without extra reference circuit
- AC-coupled limiter amplifier for sound intercarrier signal with input switch for additional FM signal
- Two alignment-free FM-PLL demodulators with high linearity
- SIF input for single reference QSS mode (PLL controlled); SIF AGC detector for gain controlled SIF amplifier; single reference QSS mixer able to operate in high performance single reference QSS mode
- AM demodulator without extra reference circuit
- Stabilizer circuit for ripple rejection and to achieve constant output signals
- ESD protection for all pins.

**GENERAL DESCRIPTION**

The TDA9815 is an integrated circuit for multistandard vision IF signal processing (inclusive MAC) and sound AM and dual FM demodulation, with single reference QSS-IF in TV and VCR sets.

**ORDERING INFORMATION**

TYPE NUMBER	PACKAGE		
	NAME	DESCRIPTION	VERSION
TDA9815	SDIP32	plastic shrink dual in-line package; 32 leads (400 mil)	SOT232-1

# Multistandard/MAC VIF-PLL with QSS-IF and dual FM-PLL/AM demodulator

TDA9815

## QUICK REFERENCE DATA

SYMBOL	PARAMETER	CONDITIONS	MIN.	TYP.	MAX.	UNIT
$V_P$	supply voltage		4.5	5	5.5	V
$I_P$	supply current		93	109	125	mA
$V_{i\text{ VIF(rms)}}$	vision IF input signal voltage sensitivity (RMS value)	-1 dB video at output	-	60	100	$\mu\text{V}$
$V_{o\text{ CVBS(p-p)}}$	CVBS output signal voltage (peak-to-peak value)		1.7	2.0	2.3	V
$B_{-3}$	-3 dB video bandwidth on pin CVBS	B/G and L standard; $C_L < 20\text{ pF}$ ; $R_L > 1\text{ k}\Omega$ ; AC load	7	8	-	MHz
		MAC standard	11	14	-	MHz
S/N (W)	weighted signal-to-noise ratio for video		56	60	-	dB
$IM_{\alpha 1.1}$	intermodulation attenuation at 'blue'	$f = 1.1\text{ MHz}$	58	64	-	dB
$IM_{\alpha 3.3}$	intermodulation attenuation at 'blue'	$f = 3.3\text{ MHz}$	58	64	-	dB
$\alpha_{H(\text{sup})}$	suppression of harmonics in video signal		35	40	-	dB
$V_{i\text{ SIF(rms)}}$	sound IF input signal voltage sensitivity (RMS value)	-3 dB at intercarrier output	-	30	70	$\mu\text{V}$
$V_{o(\text{rms})}$	audio output signal voltage for FM (RMS value)	B/G standard; 54% modulation	-	0.5	-	V
	audio output signal voltage for AM (RMS value)	L standard; 54% modulation	-	0.5	-	V
THD	total harmonic distortion	54% modulation	-	0.15	0.5	%
			-	0.5	1.0	%
S/N (W)	weighted signal-to-noise ratio	54% modulation	-	60	-	dB
			47	53	-	dB

# Multistandard/MAC VIF-PLL with QSS-IF and dual FM-PLL/AM demodulator

TDA9815

## BLOCK DIAGRAM

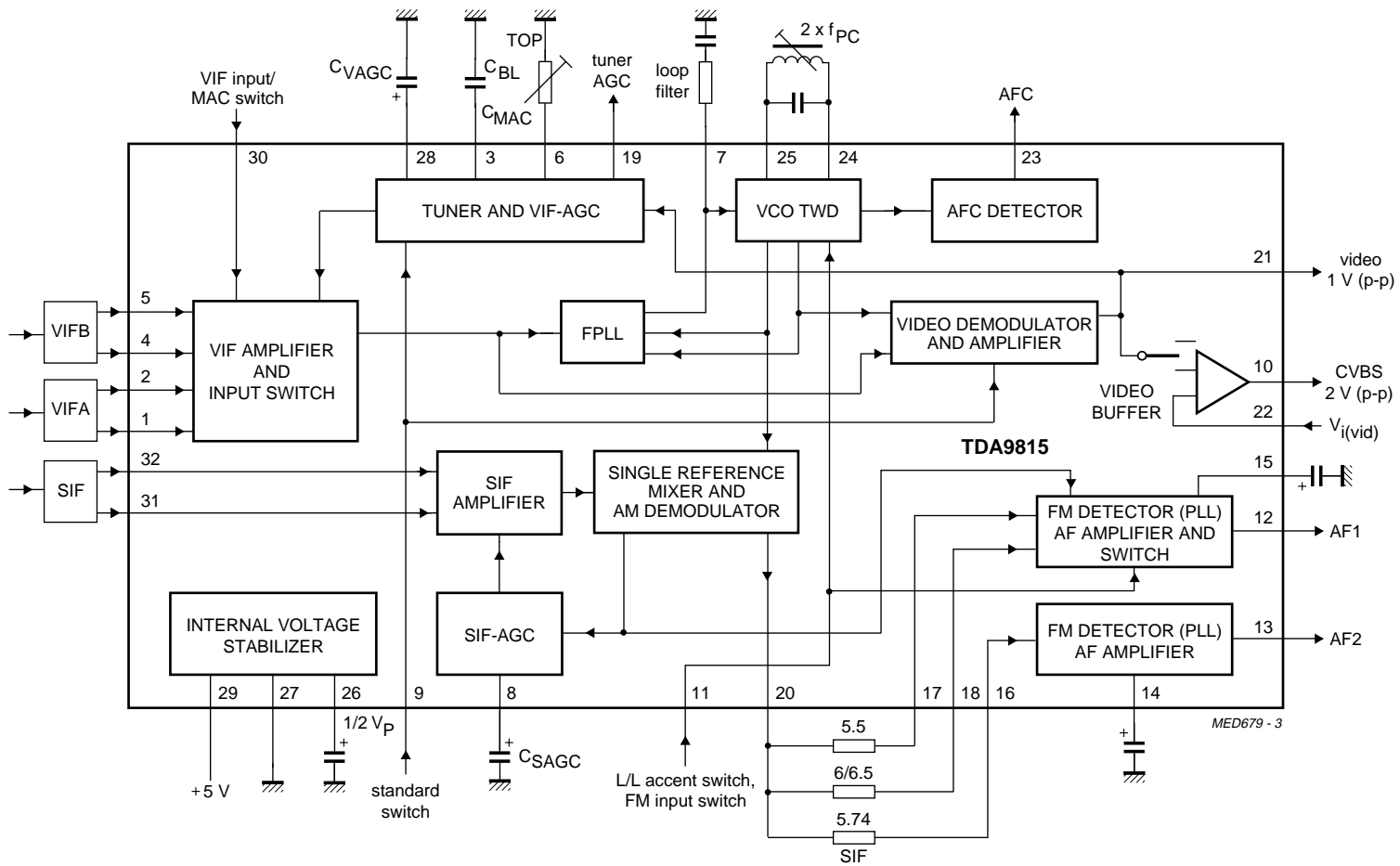

Fig.1 Block diagram.

Multistandard/MAC VIF-PLL with QSS-IF  
and dual FM-PLL/AM demodulator

TDA9815

PINNING

SYMBOL	PIN	DESCRIPTION
$V_{i\ VIF1}$	1	VIF differential input signal voltage 1
$V_{i\ VIF2}$	2	VIF differential input signal voltage 2
$C_{BL/MAC}$	3	black level detector/MAC capacitor
$V_{i\ VIF3}$	4	VIF differential input signal voltage 3
$V_{i\ VIF4}$	5	VIF differential input signal voltage 4
TADJ	6	tuner AGC takeover adjust (TOP)
$T_{PLL}$	7	PLL loop filter
$C_{SAGC}$	8	SIF AGC capacitor
STD	9	standard switch
$V_{o\ CVBS}$	10	CVBS output signal voltage
FMLSWI	11	FM input select and L/L accent switch
$V_{o\ AF1}$	12	audio voltage frequency output 1
$V_{o\ AF2}$	13	audio voltage frequency output 2
$C_{DEC2}$	14	decoupling capacitor 2
$C_{DEC1}$	15	decoupling capacitor 1
$V_{i\ FM2}$	16	sound intercarrier input voltage 2
$V_{i\ FM1}$	17	sound intercarrier input voltage 1
$V_{i\ FM3}$	18	sound intercarrier input voltage 3
TAGC	19	tuner AGC output
$V_{o\ QSS}$	20	single reference QSS output voltage
$V_{o(vid)}$	21	composite video output voltage
$V_{i(vid)}$	22	video buffer input voltage
AFC	23	AFC output
VCO1	24	VCO1 reference circuit for $2f_{PC}$
VCO2	25	VCO2 reference circuit for $2f_{PC}$
$C_{ref}$	26	$\frac{1}{2}V_P$ reference capacitor
GND	27	ground
$C_{VAGC}$	28	VIF-AGC capacitor
$V_P$	29	supply voltage
INSWI	30	VIF input switch
$V_{i\ SIF1}$	31	SIF differential input signal voltage 1
$V_{i\ SIF2}$	32	SIF differential input signal voltage 2

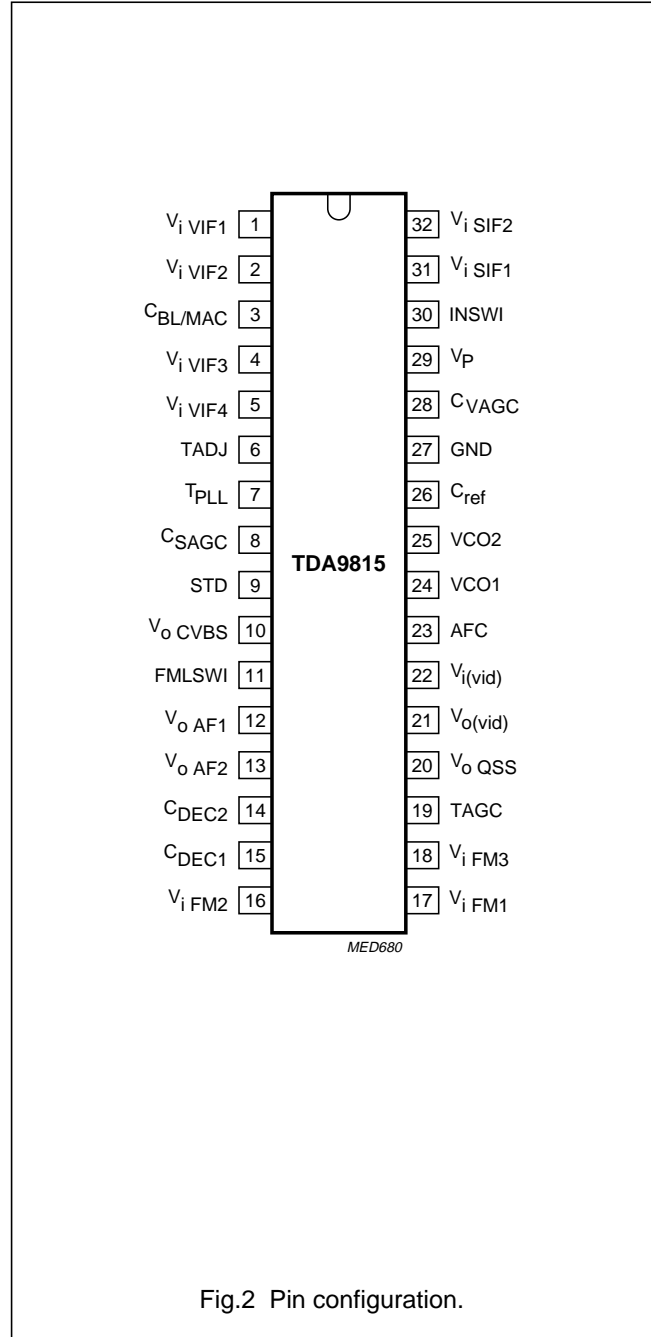

Fig.2 Pin configuration.

## Multistandard/MAC VIF-PLL with QSS-IF and dual FM-PLL/AM demodulator

TDA9815

### FUNCTIONAL DESCRIPTION

The integrated circuit comprises the functional blocks as shown in Fig.1:

- Vision IF amplifier and input switch
- Tuner and VIF-AGC
- Frequency Phase Locked Loop detector (FPLL)
- VCO, Travelling Wave Divider (TWD) and AFC
- Video demodulator and amplifier
- Video buffer
- SIF amplifier and AGC
- Single reference QSS mixer
- AM demodulator
- FM-PLL demodulator
- Internal voltage stabilizer and  $\frac{1}{2}V_P$ -reference.

#### Vision IF amplifier and input switch

The vision IF amplifier consists of three AC-coupled differential amplifier stages. Each differential stage comprises a feedback network controlled by emitter degeneration. The first differential stage is extended by two pairs of emitter followers to provide two IF input channels. The VIF input can be selected by pin 30.

#### Tuner and VIF-AGC

The AGC capacitor voltage is transferred to an internal IF control signal, and is fed to the tuner AGC to generate the tuner AGC output current (open-collector output). The tuner AGC takeover point can be adjusted. This allows the tuner and the SAW filter to be matched to achieve the optimum IF input level.

The AGC detector charges/discharges the AGC capacitor to the required voltage for setting of VIF and tuner gain in order to keep the video signal at a constant level.

Therefore for negative video modulation the sync level and for positive video modulation the peak white level of the video signal is detected. In order to reduce the reaction time for positive (or MAC) modulation, where a very large time constant is needed, an additional level detector increases the discharging current of the AGC capacitor (fast mode) in the event of a decreasing VIF amplitude step. The additional level information is given by the black level detector voltage.

#### Frequency Phase Locked Loop detector (FPLL)

The VIF-amplifier output signal is fed into a frequency detector and into a phase detector via a limiting amplifier. During acquisition the frequency detector produces a DC current proportional to the frequency difference between the input and the VCO signal. After frequency lock-in the phase detector produces a DC current proportional to the phase difference between the VCO and the input signal. The DC current of either frequency detector or phase detector is converted into a DC voltage via the loop filter, which controls the VCO frequency. In the event of positive modulated signals the phase detector is gated by composite sync in order to avoid signal distortion for overmodulated VIF signals.

#### VCO, Travelling Wave Divider (TWD) and AFC

The VCO operates with a resonance circuit (with L and C in parallel) at double the PC frequency. The VCO is controlled by two integrated variable capacitors. The control voltage required to tune the VCO from its free-running frequency to actually double the PC frequency is generated by the frequency-phase detector (FPLL) and fed via the loop filter to the first variable capacitor. This control voltage is amplified and additionally converted into a current which represents the AFC output signal. The VCO centre frequency can be decreased (required for L accent standard) by activating an additional internal capacitor. This is achieved by using the L accent switch. In this event the second variable capacitor can be controlled by a variable resistor at the L accent switch for setting the VCO centre frequency to the required L accent value. At centre frequency the AFC output current is equal to zero.

The oscillator signal is divided-by-two with a TWD which generates two differential output signals with a 90 degree phase difference independent of the frequency.

#### Video demodulator and amplifier

The video demodulator is realized by a multiplier which is designed for low distortion and large bandwidth. The vision IF input signal is multiplied with the 'in phase' signal of the travelling wave divider output. In the demodulator stage the video signal polarity can be switched in accordance with the TV standard.

## Multistandard/MAC VIF-PLL with QSS-IF and dual FM-PLL/AM demodulator

TDA9815

The demodulator output signal is fed via an integrated low-pass filter for attenuation of the carrier harmonics to the video amplifier. The video amplifier is realized by an operational amplifier with internal feedback and high bandwidth. A low-pass filter is integrated to achieve an attenuation of the carrier harmonics for B/G and L standard. The standard dependent level shift in this stage delivers the same sync level for positive and negative modulation. The video output signal is 1 V (p-p) for nominal vision IF modulation.

### Video buffer

For an easy adaption of the sound traps an operational amplifier with internal feedback is used in the event of B/G and L standard. This amplifier is featured with a high bandwidth and 7 dB gain. The input impedance is adapted for operating in combination with ceramic sound traps. The output stage delivers a nominal 2 V (p-p) positive video signal. Noise clipping is provided.

For MAC standard a second buffer amplifier with 6 dB gain is used. This buffer amplifier is selected by the standard switch.

### SIF amplifier and AGC

The sound IF amplifier consists of two AC-coupled differential amplifier stages. Each differential stage comprises a controlled feedback network provided by emitter degeneration.

The SIF AGC detector is related to the SIF input signals (average level of AM or FM carriers) and controls the SIF amplifier to provide a constant SIF signal to the AM demodulator and single reference QSS mixer. The SIF AGC reaction time is set to 'slow' for nominal video conditions. But with a decreasing VIF amplitude step the SIF AGC is set to 'fast' mode controlled by the VIF-AGC detector. In FM mode this reaction time is also set to 'fast' controlled by the standard switch.

### Single reference QSS mixer

The single reference QSS mixer is realized by a multiplier. The SIF amplifier output signal is fed to the single reference QSS mixer and converted to intercarrier frequency by the regenerated picture carrier (VCO). The mixer output signal is fed via a high-pass for attenuation of the video signal components to the output pin 20. With this system a high performance hi-fi stereo sound processing can be achieved.

### AM demodulator

The AM demodulator is realized by a multiplier. The modulated SIF amplifier output signal is multiplied in phase with the limited (AM is removed) SIF amplifier output signal. The demodulator output signal is fed via an integrated low-pass filter for attenuation of the carrier harmonics to the AF amplifier.

### FM-PLL demodulator

Each FM-PLL demodulator consists of a limiter, an FM-PLL and an AF amplifier. The limiter provides the amplification and limitation of the FM sound intercarrier signal before demodulation. The result is high sensitivity and AM suppression. The amplifier consists of 7 stages which are internally AC-coupled in order to minimize the DC offset and to save pins for DC decoupling.

At the input of one limiter a signal switch is available for selecting one of the two intercarrier signals. Controlled by the voltage at pin 11, either the input pin 17 or pin 18 is active for handling different intercarrier frequencies.

The other limiter is extended with an additional level detector consisting of a rectifier and a comparator. By means of this the AF2 signal is set to mute and the PLL VCO is switched off, if the intercarrier signal at pin 16 is below 1 mV (RMS) in order to avoid false identification of a stereo decoder. Note that noise at pin 16 disables the mute state (at low SIF input signal), but this will not lead to false identification. This 'auto-mute' function can be disabled by connecting a 5.6 k $\Omega$  resistor from pin 16 to  $V_P$  (see Fig.13).

Furthermore the AF output signals can be muted by connecting a resistor between the limiter inputs pin 16 or pin 17 and ground.

The FM-PLL consists of an integrated relaxation oscillator, an integrated loop filter and a phase detector. The oscillator is locked to the FM intercarrier signal, output from the limiter. As a result of locking, the oscillator frequency tracks with the modulation of the input signal and the oscillator control voltage is superimposed by the AF voltage. The FM-PLL operates as an FM-demodulator.

## Multistandard/MAC VIF-PLL with QSS-IF and dual FM-PLL/AM demodulator

TDA9815

The AF amplifier consists of two parts:

1. The AF preamplifier for FM sound is an operational amplifier with internal feedback, high gain and high common mode rejection. The AF voltage from the PLL demodulator, by principle a small output signal, is amplified by approximately 33 dB. The low-pass characteristic of the amplifier reduces the harmonics of the intercarrier signal at the sound output terminal. An additional DC control circuit is implemented to keep the DC level constant, independent of process spread.
2. The AF output amplifier (10 dB) provides the required output level by a rail-to-rail output stage. This amplifier makes use of an input selector for switching to AM/FM or mute state, controlled by the standard switching voltage and the mute switching voltage.

For all audio output signals the constant reference voltage cannot be used because large output signals are required. Therefore these signals refer to half the supply voltage to achieve a symmetrical headroom, especially for the rail-to-rail output stage. For ripple and noise attenuation the  $\frac{1}{2}V_P$  voltage has to be filtered via a low-pass filter by using an external capacitor together with an integrated resistor ( $f_g = 5$  Hz). For a fast setting to  $\frac{1}{2}V_P$  an internal start-up circuit is added.

### Internal voltage stabilizer and $\frac{1}{2}V_P$ -reference

The bandgap circuit internally generates a voltage of approximately 1.25 V, independent of supply voltage and temperature. A voltage regulator circuit, connected to this voltage, produces a constant voltage of 3.6 V which is used as an internal reference voltage.

### LIMITING VALUES

In accordance with the Absolute Maximum Rating System (IEC 134).

SYMBOL	PARAMETER	CONDITIONS	MIN.	MAX.	UNIT
$V_P$	supply voltage (pin 29)	maximum chip temperature of 125 °C; note 1	0	7.0	V
$V_i$	voltage at pins 1 to 9, 11 to 19, 22, 23 and 26 to 32		0	$V_P$	V
$t_{s(max)}$	maximum short-circuit time		–	10	s
$V_{19}$	tuner AGC output voltage		0	13.2	V
$T_{stg}$	storage temperature		–25	+150	°C
$T_{amb}$	operating ambient temperature		–20	+70	°C
$V_{es}$	electrostatic handling voltage	note 2	–300	+300	V

### Notes

1.  $I_P = 125$  mA;  $T_{amb} = 70$  °C;  $R_{th(j-a)} = 60$  K/W.
2. Machine model class B ( $L = 2.5$   $\mu$ H).

### THERMAL CHARACTERISTICS

SYMBOL	PARAMETER	CONDITIONS	VALUE	UNIT
$R_{th(j-a)}$	thermal resistance from junction to ambient	in free air	60	K/W



# Multistandard/MAC VIF-PLL with QSS-IF and dual FM-PLL/AM demodulator

TDA9815

## CHARACTERISTICS

$V_P = 5\text{ V}$ ;  $T_{amb} = 25\text{ °C}$ ; see Table 1 for input frequencies and carrier ratios; input level  $V_{i\text{IF } 1-2, 4-5} = 10\text{ mV RMS}$  value (sync-level for B/G, peak white level for L, peak level for MAC); video modulation DSB; residual carrier B/G and MAC: 10%; L = 3%; video signal in accordance with "CCIR, line 17"; measurements taken in Fig.13; unless otherwise specified.

SYMBOL	PARAMETER	CONDITIONS	MIN.	TYP.	MAX.	UNIT
<b>Supply (pin 29)</b>						
$V_P$	supply voltage	note 1	4.5	5	5.5	V
$I_P$	supply current		93	109	125	mA
<b>Vision IF amplifier (pins 1, 2, 4 and 5)</b>						
$V_{i\text{ VIF(rms)}}$	input signal voltage sensitivity (RMS value)	B/G standard; -1 dB video at output	-	60	100	$\mu\text{V}$
$V_{i\text{ max(rms)}}$	maximum input signal voltage (RMS value)	B/G standard; +1 dB video at output	120	200	-	mV
$\Delta V_{o(\text{int})}$	internal IF amplitude difference between picture and sound carrier	within AGC range	-	0.7	1	dB
		B/G standard; $\Delta f = 5.5\text{ MHz}$ MAC standard; $\Delta f = 8.4\text{ MHz}$	-	1.0	1.3	dB
$G_{\text{IFCr}}$	IF gain control range	see Fig.3	65	70	-	dB
$R_{i(\text{diff})}$	differential input resistance	note 2; activated input	1.7	2.2	2.7	k $\Omega$
$C_{i(\text{diff})}$	differential input capacitance	note 2; activated input	1.2	1.7	2.5	pF
$V_{1,2,4,5}$	DC input voltage	note 2; activated input	-	3.4	-	V
$R_i$	input resistance to ground	note 2; not activated input	-	1.1	-	k $\Omega$
$V_{1,2,4,5}$	DC input voltage	note 2; not activated input	-	0.2	-	V
$\alpha_{\text{ct IF}}$	crosstalk attenuation of IF input switch at pins 1, 2, 4 and 5	notes 2 and 3	55	60	-	dB
<b>True synchronous video demodulator; note 4</b>						
$f_{\text{VCO(max)}}$	maximum oscillator frequency for carrier regeneration	$f = 2f_{\text{PC}}$	125	130	-	MHz
$\Delta f_{\text{osc}}/\Delta T$	oscillator drift as a function of temperature	oscillator is free-running; $I_{\text{AFC}} = 0$ ; note 5	-	-	$\pm 20 \times 10^{-6}$	$\text{K}^{-1}$
$V_{0\text{ ref(rms)}}$	oscillator voltage swing at pins 24 and 25 (RMS value)		70	100	130	mV
$f_{\text{PC CR}}$	picture carrier capture range	B/G, L and MAC standard	$\pm 1.4$	$\pm 1.8$	-	MHz
		L accent standard; $f_{\text{PC}} = 33.9\text{ MHz}$ ; $R_{11} = 5.6\text{ k}\Omega$	$\pm 0.9$	$\pm 1.2$	-	MHz
$Q_{f_{\text{PC(fr)}}$	picture carrier frequency (free-running) accuracy	L accent standard; $f_{\text{PC}} = 33.9\text{ MHz}$ ; $R_{11} = 5.6\text{ k}\Omega$	-	$\pm 200$	$\pm 400$	kHz
$f_{\text{PC(alg)CR}}$	L accent alignment frequency range	$I_{\text{AFC}} = 0$	$\pm 400$	$\pm 600$	-	kHz
$t_{\text{acq}}$	acquisition time	BL = 75 kHz; note 6	-	-	30	ms

**Multistandard/MAC VIF-PLL with QSS-IF  
and dual FM-PLL/AM demodulator**

TDA9815

SYMBOL	PARAMETER	CONDITIONS	MIN.	TYP.	MAX.	UNIT
$V_{i \text{ VIF(rms)}}$	VIF input signal voltage sensitivity for PLL to be locked (RMS value; pins 1, 2, 4 and 5)	maximum IF gain; note 7	–	30	70	$\mu\text{V}$
<b>Composite video amplifier (pin 21; sound carrier off)</b>						
$V_{o \text{ video(p-p)}}$	output signal voltage (peak-to-peak value)	see Fig.8	0.88	1.0	1.12	V
V/S	ratio between video (black-to-white) and sync level		1.9	2.33	3.0	–
$\Delta V_{o(\text{video})}$	output signal voltage difference	difference between B/G and L standard	–	–	$\pm 12$	%
$V_{21(\text{sync})}$	sync voltage level	B/G and L standard	–	1.5	–	V
$V_{21(\text{clu})}$	upper video clipping voltage level		$V_P - 1.1$	$V_P - 1$	–	V
$V_{21(\text{cll})}$	lower video clipping voltage level		–	0.7	0.9	V
$R_{o,21}$	output resistance	note 2	–	–	10	$\Omega$
$I_{\text{int } 21}$	internal DC bias current for emitter-follower		2.2	3.0	–	mA
$I_{21 \text{ max(sink)}}$	maximum AC and DC output sink current		1.6	–	–	mA
$I_{21 \text{ max(source)}}$	maximum AC and DC output source current		2.9	–	–	mA
$B_{-1}$	–1 dB video bandwidth	B/G and L standard; $C_L < 50 \text{ pF}$ ; $R_L > 1 \text{ k}\Omega$ ; AC load	5	6	–	MHz
$B_{-3}$	–3 dB video bandwidth	B/G and L standard; $C_L < 50 \text{ pF}$ ; $R_L > 1 \text{ k}\Omega$ ; AC load	7	8	–	MHz
$\alpha_{H(\text{sup})}$	suppression of video signal harmonics	$C_L < 50 \text{ pF}$ ; $R_L > 1 \text{ k}\Omega$ ; AC load; note 8a	35	40	–	dB
PSRR	power supply ripple rejection at pin 21	video signal; grey level; see Fig.11 B/G standard L standard	32 26	35 30	– –	dB dB
<b>CVBS buffer amplifier (only) and noise clipper (pins 10 and 22)</b>						
$R_{i,22}$	input resistance	note 2	2.6	3.3	4.0	$\text{k}\Omega$
$C_{i,22}$	input capacitance	note 2	1.4	2	3.0	pF
$V_{i,22}$	DC input voltage		1.4	1.7	2.0	V
$G_v$	voltage gain	B/G and L standard; note 9	6.5	7	7.5	dB
$V_{10(\text{clu})}$	upper video clipping voltage level		3.9	4.0	–	V

**Multistandard/MAC VIF-PLL with QSS-IF  
and dual FM-PLL/AM demodulator**

TDA9815

SYMBOL	PARAMETER	CONDITIONS	MIN.	TYP.	MAX.	UNIT
$V_{10(\text{cll})}$	lower video clipping voltage level		–	1.0	1.1	V
$R_{o,10}$	output resistance	note 2	–	–	10	$\Omega$
$I_{\text{int } 10}$	DC internal bias current for emitter-follower		2.0	2.5	–	mA
$I_{o,10 \text{ max}(\text{sink})}$	maximum AC and DC output sink current		1.4	–	–	mA
$I_{o,10 \text{ max}(\text{source})}$	maximum AC and DC output source current		2.4	–	–	mA
$B_{-1}$	–1 dB video bandwidth	B/G and L standard; $C_L < 20 \text{ pF}$ ; $R_L > 1 \text{ k}\Omega$ ; AC load	8.4	11	–	MHz
$B_{-3}$	–3 dB video bandwidth	B/G and L standard; $C_L < 20 \text{ pF}$ ; $R_L > 1 \text{ k}\Omega$ ; AC load	11	14	–	MHz
<b>Measurements from IF input to CVBS output (pin 10; 330 <math>\Omega</math> between pins 21 and 22, sound carrier off)</b>						
$V_o \text{ CVBS}(\text{p-p})$	CVBS output signal voltage on pin 10 (peak-to-peak value)	note 9	1.7	2.0	2.3	V
$V_o \text{ CVBS}(\text{sync})$	sync voltage level	B/G standard	–	1.35	–	V
		L standard	–	1.35	–	V
$V_o \text{ CVBS}(\text{peak})$	peak voltage level	MAC standard	–	1.35	–	V
$\Delta V_o$	deviation of CVBS output signal voltage at B/G	50 dB gain control	–	–	0.5	dB
		30 dB gain control	–	–	0.1	dB
$\Delta V_o(\text{blB/G})$	black level tilt in B/G standard	gain variation; note 10	–	–	1	%
$\Delta V_o(\text{blL})$	black level tilt for worst case in L standard	picture carrier modulated by test line (VITS) only; gain variation; note 10	–	–	1.9	%
$G_{\text{diff}}$	differential gain	"CCIR, line 330"	–	2	5	%
$\varphi_{\text{diff}}$	differential phase	"CCIR, line 330"	–	1	2	deg
$B_{-1}$	–1 dB video bandwidth	$C_L < 20 \text{ pF}$ ; $R_L > 1 \text{ k}\Omega$ ; AC load				
		B/G and L standard	5	6	–	MHz
		MAC standard	8.4	11	–	MHz
$B_{-3}$	–3 dB video bandwidth	$C_L < 20 \text{ pF}$ ; $R_L > 1 \text{ k}\Omega$ ; AC load				
		B/G and L standard	7	8	–	MHz
		MAC standard	11	14	–	MHz
$S/N (W)$	weighted signal-to-noise ratio	see Fig.5 and note 11	56	60	–	dB
$S/N$	unweighted signal-to-noise ratio	see Fig.5 and note 11	49	53	–	dB

# Multistandard/MAC VIF-PLL with QSS-IF and dual FM-PLL/AM demodulator

TDA9815

SYMBOL	PARAMETER	CONDITIONS	MIN.	TYP.	MAX.	UNIT
IM $\alpha_{1,1}$	intermodulation attenuation at 'blue'	f = 1.1 MHz; see Fig.6 and note 12	58	64	–	dB
	intermodulation attenuation at 'yellow'	f = 1.1 MHz; see Fig.6 and note 12	60	66	–	dB
IM $\alpha_{3,3}$	intermodulation attenuation at 'blue'	f = 3.3 MHz; see Fig.6 and note 12	58	64	–	dB
	intermodulation attenuation at 'yellow'	f = 3.3 MHz; see Fig.6 and note 12	59	65	–	dB
$\alpha_{pc(rms)}$	residual picture carrier (RMS value)	fundamental wave and harmonics				
		B/G and L standard	–	2	5	mV
		MAC standard	–	5	20	mV
$\Delta f_{unwanted(p-p)}$	robustness for unwanted frequency deviation of picture carrier (peak-to-peak value)	L standard; residual carrier: 3%; serration pulses: 50%; note 2	–	–	12	kHz
$\Delta\phi$	robustness for modulator imbalance	L standard; residual carrier: 0%; serration pulses: 50%; note 2	–	–	3	%
$\alpha_{H(sup)}$	suppression of video signal harmonics	note 8a	35	40	–	dB
$\alpha_{H(spur)}$	spurious elements	note 8b	40	–	–	dB
PSRR	power supply ripple rejection at pin 10	video signal; grey level; see Fig.11				
		B/G standard	25	28	–	dB
		L standard	20	23	–	dB
<b>VIF-AGC detector (pin 28)</b>						
I <sub>28</sub>	charging current	B/G, L and MAC standard; note 10	0.75	1	1.25	mA
	additional charging current	L standard in event of missing VITS pulses and no white video content	1.9	2.5	3.1	$\mu$ A
	discharging current	B/G standard	15	20	25	$\mu$ A
		normal mode L and MAC standard	225	300	375	nA
		fast mode L and MAC standard	30	40	50	$\mu$ A
t <sub>resp</sub>	AGC response to an increasing VIF step	B/G, L and MAC standard; note 13	–	0.05	0.1	ms/dB
	AGC response to a decreasing VIF step	B/G standard	–	2.2	3.5	ms/dB
		fast mode L and MAC standard	–	1.1	1.8	ms/dB
		normal mode L and MAC standard; note 13	–	150	240	ms/dB

**Multistandard/MAC VIF-PLL with QSS-IF  
and dual FM-PLL/AM demodulator**

TDA9815

SYMBOL	PARAMETER	CONDITIONS	MIN.	TYP.	MAX.	UNIT
$\Delta I_F$	VIF amplitude step for activating fast AGC mode	L and MAC standard	-2	-6	-10	dB
$V_{3(th)}$	threshold voltage level additional charging current	see Fig.8 L standard L standard; fast mode L MAC standard; fast mode MAC	- - -	1.95 1.65 1.9	- - -	V V V
<b>Tuner AGC (pin 19)</b>						
$V_{i(rms)}$	IF input signal voltage for minimum starting point of tuner takeover (RMS value)	input at pins 1, 2, 4 and 5; $R_{TOP} = 22 \text{ k}\Omega$ ; $I_{19} = 0.4 \text{ mA}$	-	2	5	mV
	IF input signal voltage for maximum starting point of tuner takeover (RMS value)	input at pins 1, 2, 4 and 5; $R_{TOP} = 0 \text{ }\Omega$ ; $I_{19} = 0.4 \text{ mA}$	50	100	-	mV
$V_{o,19}$	permissible output voltage	from external source; note 2	-	-	13.2	V
$V_{sat,19}$	saturation voltage	$I_{19} = 1.5 \text{ mA}$	-	-	0.2	V
$\Delta V_{TOP,19}/\Delta T$	variation of takeover point by temperature	$I_{19} = 0.4 \text{ mA}$	-	0.03	0.07	dB/K
$I_{19(sink)}$	sink current	see Fig.3 no tuner gain reduction; $V_{19} = 13.2 \text{ V}$	-	-	1	$\mu\text{A}$
		maximum tuner gain reduction	1.5	2	2.6	mA
$\Delta G_{IF}$	IF slip by automatic gain control	tuner gain current from 20 to 80%	-	6	8	dB
<b>AFC circuit (pin 23); see Fig.7 and note 14</b>						
S	control steepness $\Delta I_{23}/\Delta f$	note 15	0.5	0.75	1.0	$\mu\text{A}/\text{kHz}$
$\Delta f_{IF}/\Delta T$	frequency variation by temperature	$I_{AFC} = 0$ ; note 6 B/G and L standard	-	-	$\pm 20 \times 10^{-6}$	$\text{K}^{-1}$
		L accent standard	-	-	$\pm 60 \times 10^{-6}$	$\text{K}^{-1}$
$V_{o,23}$	output voltage upper limit	see Fig.7 without external components	$V_P - 0.6$	$V_P - 0.3$	-	V
	output voltage lower limit		-	0.3	0.6	V
$I_{o,23(source)}$	output source current	see Fig.7	150	200	250	$\mu\text{A}$
$I_{o,23(sink)}$	output sink current		150	200	250	$\mu\text{A}$
$\Delta I_{23(p-p)}$	residual video modulation current (peak-to-peak value)	B/G and L standard	-	20	30	$\mu\text{A}$
<b>Sound IF amplifier (pins 31 and 32)</b>						
$V_{i \text{ SIF}(rms)}$	input signal voltage sensitivity (RMS value)	FM mode; -3 dB at intercarrier output pin 20	-	30	70	$\mu\text{V}$
		AM mode; -3 dB at AF output pin 12	-	70	100	$\mu\text{V}$

# Multistandard/MAC VIF-PLL with QSS-IF and dual FM-PLL/AM demodulator

TDA9815

SYMBOL	PARAMETER	CONDITIONS	MIN.	TYP.	MAX.	UNIT
$V_{i \max(\text{rms})}$	maximum input signal voltage (RMS value)	FM mode; +1 dB at intercarrier output pin 20	50	70	–	mV
		AM mode; +1 dB at AF output pin 12	80	140	–	mV
$G_{\text{SIFcr}}$	SIF gain control range	FM and AM mode; see Fig.4	60	67	–	dB
$R_{i(\text{diff})}$	differential input resistance	note 2	1.7	2.2	2.7	k $\Omega$
$C_{i(\text{diff})}$	differential input capacitance	note 2	1.2	1.7	2.5	pF
$V_{I(31,32)}$	DC input voltage		–	3.4	–	V
$\alpha_{\text{ct(SIF,VIF)}}$	crosstalk attenuation between SIF and VIF input	between pins 1, 2, 4 and 5 and pins 31 and 32; note 3	50	–	–	dB
<b>SIF-AGC detector (pin 8)</b>						
$I_8$	charging current	FM mode	8	12	16	$\mu\text{A}$
		AM mode	0.8	1.2	1.6	$\mu\text{A}$
	discharging current	FM mode	8	12	16	$\mu\text{A}$
		normal mode AM	1	1.4	1.8	$\mu\text{A}$
		fast mode AM	60	85	110	$\mu\text{A}$
<b>Single reference QSS intercarrier mixer (B/G standard; pin 20)</b>						
$V_{o(\text{rms})}$	IF intercarrier level (RMS value)	SC <sub>1</sub> ; sound carrier 2 off	75	100	125	mV
$B_{-3}$	–3 dB intercarrier bandwidth	upper limit	7.5	9	–	MHz
$\alpha_{\text{SC}(\text{rms})}$	residual sound carrier (RMS value)	fundamental wave and harmonics	–	2	–	mV
$R_{o,20}$	output resistance	note 2	–	–	25	$\Omega$
$V_{O,20}$	DC output voltage		–	2.0	–	V
$I_{\text{int } 20}$	DC internal bias current for emitter-follower		1.5	1.9	–	mA
$I_{20 \max(\text{sink})}$	maximum AC and DC output sink current		1.1	1.5	–	mA
$I_{20 \max(\text{source})}$	maximum AC and DC output source current		3.0	3.5	–	mA
<b>FM input stage and limiter amplifier 1 (pins 17 and 18); note 16</b>						
$V_{i \text{ FM}(\text{rms})}$	input signal voltage for lock-in (RMS value)		–	–	100	$\mu\text{V}$
$V_{i \text{ FM}(\text{rms})}$	input signal voltage (RMS value)	$\frac{S+N}{N} = 40 \text{ dB}$	–	300	400	$\mu\text{V}$
	allowed input signal voltage (RMS value)		200	–	–	mV
$R_{i(17,18)}$	input resistance	activated input; note 2	480	600	720	$\Omega$
		not activated input; note 2	–	–	100	$\Omega$
$V_{I(17,18)}$	DC input voltage	activated input	–	2.8	–	V
		not activated input pin 17	–	1.8	–	V
		not activated input pin 18	–	–	0.1	V

# Multistandard/MAC VIF-PLL with QSS-IF and dual FM-PLL/AM demodulator

TDA9815

SYMBOL	PARAMETER	CONDITIONS	MIN.	TYP.	MAX.	UNIT
$\alpha_{cr}$	crosstalk attenuation	activated to not activated input; not activated input terminated with an impedance of 600 $\Omega$ (AC-coupled)	44	50	–	dB
<b>Limiter amplifier 2 (pin 16); note 16</b>						
$V_{i\text{ FM(rms)}}$	input signal voltage for lock-in (RMS value)		–	–	100	$\mu\text{V}$
$V_{i\text{ FM(rms)}}$	input signal voltage (RMS value)	$\frac{S+N}{N} = 40\text{ dB}$ PLL1 has to be in locked mode; auto mute off	–	300	400	$\mu\text{V}$
	allowed input signal voltage (RMS value)		200	–	–	mV
	input signal voltage for no auto mute; PLL enabled (RMS value)		0.7	1	1.5	mV
$HYS_{16}$	hysteresis of level detector for auto mute		–3	–6	–8	dB
$R_{i,16}$	input resistance	note 2	480	600	720	$\Omega$
$V_{I,16}$	DC input voltage		–	2.0	–	V
<b>FM-PLL demodulator</b>						
$f_{i\text{ FM(catch)}}$	catching range of PLL	upper limit	7.0	–	–	MHz
		lower limit	–	–	4.0	MHz
$f_{i\text{ FM(hold)}}$	holding range of PLL	upper limit	8.0	–	–	MHz
		lower limit	–	–	3.5	MHz
$t_{acq}$	acquisition time		–	–	4	$\mu\text{s}$
<b>FM operation (B/G standard; pins 12 and 13); notes 16 and 16a</b>						
$V_{o\text{ AF12,13(rms)}}$	AF output signal voltage (RMS value)	27 kHz (54% FM deviation); see Fig.13 and note 17 $R_x = R_y = 470\ \Omega$	200	250	300	mV
		$R_x = R_y = 0\ \Omega$	400	500	600	mV
$V_{o\text{ AF12,13(cl)}}$	AF output clipping signal voltage level	THD < 1.5%	1.3	1.4	–	V
$\Delta f_{AF}$	frequency deviation	THD < 1.5%; note 17	–	–	53	kHz
$\Delta V_o/\Delta T$	temperature drift of AF output signal voltage		–	$3 \times 10^{-3}$	$7 \times 10^{-3}$	dB/K
$V_{14,15}$	DC voltage at decoupling capacitor	voltage dependent on VCO frequency; note 18	1.2	–	3.0	V
$R_{12,13}$	output resistance	note 2	–	–	100	$\Omega$
$V_{12,13}$	DC output voltage	tracked with supply voltage	–	$\frac{1}{2}V_P$	–	V
$I_{12,13\text{max(sink)}}$	maximum AC and DC output sink current		–	–	1.1	mA

# Multistandard/MAC VIF-PLL with QSS-IF and dual FM-PLL/AM demodulator

TDA9815

SYMBOL	PARAMETER	CONDITIONS	MIN.	TYP.	MAX.	UNIT
$I_{12,13\max(\text{source})}$	maximum AC and DC output source current		–	–	1.1	mA
$B_{-3}$	–3 dB video bandwidth		100	125	–	kHz
THD	total harmonic distortion		–	0.15	0.5	%
S/N (W)	weighted signal-to-noise ratio	FM-PLL only; with 50 $\mu$ s de-emphasis; 27 kHz (54% FM deviation); "CCIR 468-4"	55	60	–	dB
$\alpha_{SC(\text{rms})}$	residual sound carrier (RMS value)	fundamental wave and harmonics	–	–	75	mV
$\alpha_{AM}$	AM suppression	50 $\mu$ s de-emphasis; AM: f = 1 kHz; m = 0.3 refer to 27 kHz (54% FM deviation)	46	50	–	dB
$\alpha_{12,13}$	mute attenuation of AF signal	B/G and L standard	70	80	–	dB
$\Delta V_{12,13}$	DC jump voltage of AF output terminals for switching AF output to mute state and vice versa	FM-PLLs in lock mode; note 19	–	$\pm 50$	$\pm 150$	mV
PSRR	power supply ripple rejection at pins 12 and 13	$R_x = R_y = 0 \Omega$ ; see Figs 11 and 13	22	28	–	dB
<b>Single reference QSS AF performance for FM operation (B/G standard);</b> (notes 20, 21 and 22; see Table 1)						
S/N (W)	weighted signal-to-noise ratio ( $SC_1/SC_2$ )	PC/SC <sub>1</sub> ratio at pins 1 and 2; 27 kHz (54% FM deviation); "CCIR 468-4"	40	–	–	dB
		black picture	53/48	58/55	–	dB
		white picture	50/46	55/52	–	dB
		6 kHz sine wave; black-to-white modulation	42/40	48/46	–	dB
		250 kHz square wave; black-to-white modulation; see note 2 in Fig.13	45/42	53/50	–	dB
		sound carrier subharmonics; f = 2.75 MHz $\pm$ 3 kHz	45/44	51/50	–	dB
		sound carrier subharmonics; f = 2.87 MHz $\pm$ 3 kHz	46/45	52/51	–	dB
<b>AM operation (L standard; pin 12);</b> note 23						
$V_{o\text{ AF}12(\text{rms})}$	AF output signal voltage (RMS value)	54% modulation	400	500	600	mV
THD	total harmonic distortion	54% modulation; see Fig.10	–	0.5	1.0	%
$B_{-3}$	–3 dB AF bandwidth		100	125	–	kHz



**Multistandard/MAC VIF-PLL with QSS-IF  
and dual FM-PLL/AM demodulator**

TDA9815

SYMBOL	PARAMETER	CONDITIONS	MIN.	TYP.	MAX.	UNIT
S/N (W)	weighted signal-to-noise ratio	"CCIR 468-4"; see Fig.9	47	53	–	dB
V <sub>12</sub>	DC potential voltage	tracked with supply voltage	–	1/2V <sub>P</sub>	–	V
PSRR	power supply ripple rejection	see Fig.11	22	25	–	dB
<b>Standard switch (pin 9); see also Table 2</b>						
V <sub>9</sub>	DC potential voltage for preferred settings					
	input voltage for negative standard	B/G and MAC standard; note 24	2.8	–	V <sub>P</sub>	V
	input voltage for negative standard	negative AGC <b>off</b>	1.3	–	2.3	V
	input voltage for positive standard	L standard	0	–	0.8	V
I <sub>IL</sub>	LOW-level input current	V <sub>9</sub> = 0 V	190	250	310	μA
<b>VIF input switch (pin 30); see also Table 2</b>						
V <sub>30</sub>	DC potential voltage for preferred settings					
	input voltage for VIF input A	B/G and L standard; note 24	2.8	–	V <sub>P</sub>	V
	input voltage for VIF input B	MAC standard	1.3	–	2.3	V
	input voltage for VIF input B	B/G and L standard	0	–	0.8	V
I <sub>IL</sub>	LOW-level input current	V <sub>30</sub> = 0 V	170	230	290	μA
<b>FM input and L accent switch (pin 11)</b>						
V <sub>11</sub>	DC potential voltage for FM input selection					
	input pin 17 activated	note 24	2.8	–	V <sub>P</sub>	V
	input pin 18 activated	22 kΩ potentiometer only for L accent alignment required; see Fig.13	0	–	2.0	V
	DC potential voltage for L standard VCO frequency switching					
	L standard	note 24	2.8	–	V <sub>P</sub>	V
	L accent standard and alignment		0	–	2.0	V
I <sub>IL</sub>	LOW-level input current	V <sub>11</sub> = 0 V	150	200	250	μA

**Notes to the characteristics**

1. Values of video and sound parameters are decreased at V<sub>P</sub> = 4.5 V.
2. This parameter is not tested during production and is only given as application information for designing the television receiver.
3. Source impedance: 2.3 kΩ in parallel to 12 pF (SAW filter); f<sub>IF</sub> = 38.9 MHz.

## Multistandard/MAC VIF-PLL with QSS-IF and dual FM-PLL/AM demodulator

TDA9815

4. Loop bandwidth  $BL = 75$  kHz (natural frequency  $f_n = 11$  kHz; damping factor  $d \approx 3.5$ ; calculated with sync level within gain control range). Resonance circuit of VCO:  $Q_0 > 50$ ;  $C_{ext} = 8.2$  pF  $\pm 0.25$  pF;  $C_{int} \approx 8.5$  pF (loop voltage approximately 2.7 V).
5. Temperature coefficient of external LC-circuit is equal to zero.
6.  $V_{iIF} = 10$  mV RMS;  $\Delta f = 1$  MHz (VCO frequency offset related to picture carrier frequency); white picture video modulation.
7.  $V_{iIF}$  signal for nominal video signal.
8. Measurements taken with SAW filter G3962 (sound carrier suppression: 40 dB); loop bandwidth  $BL = 75$  kHz:
  - a) Modulation VSB; sound carrier **off**;  $f_{video} > 0.5$  MHz.
  - b) Sound carrier **on**; SIF SAW filter L9453;  $f_{video} = 10$  kHz to 10 MHz.
9. The 7 dB buffer gain accounts for 1 dB loss (not valid for MAC) in the sound trap. Buffer output signal is typical 2 V (p-p), in event of CVBS video amplifier output typical 1 V (p-p). If no sound trap is applied a 330  $\Omega$  resistor must be connected from output to input (from pin 21 to pin 22).
10. The leakage current of the AGC capacitor should not exceed 1  $\mu$ A at B/G standard respectively 10 nA current at L standard. Larger currents will increase the tilt.
11. S/N is the ratio of black-to-white amplitude to the black level noise voltage (RMS value, pin 10).  $B = 5$  MHz weighted in accordance with "CCIR 567".
12. The intermodulation figures are defined:
 
$$\alpha_{1.1} = 20 \log \left( \frac{V_0 \text{ at } 4.4 \text{ MHz}}{V_0 \text{ at } 1.1 \text{ MHz}} \right) + 3.6 \text{ dB}; \alpha_{1.1} \text{ value at } 1.1 \text{ MHz referenced to black/white signal};$$

$$\alpha_{3.3} = 20 \log \left( \frac{V_0 \text{ at } 4.4 \text{ MHz}}{V_0 \text{ at } 3.3 \text{ MHz}} \right); \alpha_{3.3} \text{ value at } 3.3 \text{ MHz referenced to colour carrier}.$$
13. Response speed valid for a VIF input level range of 200  $\mu$ V up to 70 mV.
14. To match the AFC output signal to different tuning systems a current source output is provided. The test circuit is given in Fig.7. The AFC-steepness can be changed by the resistors at pin 23.
15. Depending on the ratio  $\Delta C/C_0$  of the LC resonant circuit of VCO ( $Q_0 > 50$ ; see note 4;  $C_0 = C_{int} + C_{ext}$ ).
16. Input level for second IF from an external generator with 50  $\Omega$  source impedance. AC-coupled with 10 nF capacitor,  $f_{mod} = 1$  kHz, 27 kHz (54% FM deviation) of audio references. A VIF/SIF input signal is not permitted. Pins 8 and 28 have to be connected to positive supply voltage for minimum IF gain. S/N and THD measurements are taken at 50  $\mu$ s de-emphasis. The not tested FM-PLL has to be locked to an unmodulated carrier.
  - a) Second IF input level 10 mV RMS.
17. Measured with an FM deviation of 27 kHz the typical AF output signal is 500 mV RMS ( $R_x = R_y = 0$   $\Omega$ ; see Fig.13). By using  $R_x = R_y = 470$   $\Omega$  the AF output signal is attenuated by 6 dB (250 mV RMS) and adapted to the stereo decoder family TDA9840. For handling an FM deviation of more than 53 kHz the AF output signal has to be reduced by using  $R_x$  and  $R_y$  in order to avoid clipping (THD < 1.5%). For an FM deviation up to 100 kHz an attenuation of 6 dB is recommended with  $R_x = R_y = 470$   $\Omega$ .
18. The leakage current of the decoupling capacitor (2.2  $\mu$ F) should not exceed 1  $\mu$ A.
19. In the event of activated auto mute state the second FM-PLL oscillator is switched off, if the input signal at pin 16 is missing or too weak (see Fig.13). In the event of switching the second FM-PLL oscillator on by the auto mute stage an increased DC jump is the consequence. Note, that noise at pin 16 disables the mute state (at low SIF input signal), but this will not lead to false identification of the used stereo decoder family TDA9840.

## Multistandard/MAC VIF-PLL with QSS-IF and dual FM-PLL/AM demodulator

TDA9815

20. For all S/N measurements the used vision IF modulator has to meet the following specifications:
- Incidental phase modulation for black-to-white jump less than 0.5 degrees.
  - QSS AF performance, measured with the television-demodulator AMF2 (audio output, weighted S/N ratio) better than 60 dB (deviation 27 kHz) for 6 kHz sine wave black-to-white video modulation.
  - Picture-to-sound carrier ratio;  $PC/SC_1 = 13$  dB (transmitter).
21. Measurements taken with SAW filter G3962 (Siemens) for vision IF (suppressed sound carrier) and G9350 (Siemens) for sound IF (suppressed picture carrier). Input level  $V_{iSIF} = 10$  mV RMS, 27 kHz (54% FM deviation).
22. The PC/SC ratio at pins 1 and 2 is calculated as the addition of TV transmitter PC/SC ratio and SAW filter PC/SC ratio. This PC/SC ratio is necessary to achieve the S/N(W) values as noted. A different PC/SC ratio will change these values.
23. Measurements taken with SAW filter L9453 (Siemens) for AM sound IF (suppressed picture carrier).
24. The input voltage has to be  $V_i > 2.8$  V or open-circuit.

**Table 1** Input frequencies and carrier ratios

DESCRIPTION	SYMBOL	B/G STANDARD	L STANDARD	L ACCENT STANDARD	UNIT
Picture carrier	$f_{PC}$	38.9	38.9	33.9	MHz
Sound carrier	$f_{SC1}$	33.4	32.4	40.4	MHz
	$f_{SC2}$	33.158	–	–	MHz
Picture-to-sound carrier ratio	$SC_1$	13	10	10	dB
	$SC_2$	20	–	–	dB

**Table 2** Switch logic

INPUT SWITCH (PIN 30)	STANDARD SWITCH (PIN 9)	SELECTED VIF INPUT	SELECTED STANDARD	VIDEO POLARITY	FM-PLL		AF-AMPLIFIER	
					1	2	1	2
2.8 V to $V_P$	2.8 V to $V_P$	A	B/G	negative	on	on	FM	FM
	1.3 to 2.3 V	A	B/G, with external VIF-AGC	negative	on	on	FM	FM
	0 to 0.8 V	A	L	positive	off	off	AM	mute
1.3 to 2.3 V	2.8 V to $V_P$	B	MAC (note 1)	negative	off	off	mute	mute
	1.3 to 2.3 V	B	MAC (note 1), with external VIF-AGC	negative	off	off	mute	mute
	0 to 0.8 V	B	L (note 1)	positive	off	off	AM	mute
0 to 0.8 V	2.8 V to $V_P$	B	B/G	negative	on	on	FM	FM
	1.3 to 2.3 V	B	B/G, with external VIF-AGC	negative	on	on	FM	FM
	0 to 0.8 V	B	L	positive	off	off	AM	mute

**Note**

1. Without external sound trap (video signal internally switched to video buffer).

Multistandard/MAC VIF-PLL with QSS-IF  
and dual FM-PLL/AM demodulator

TDA9815

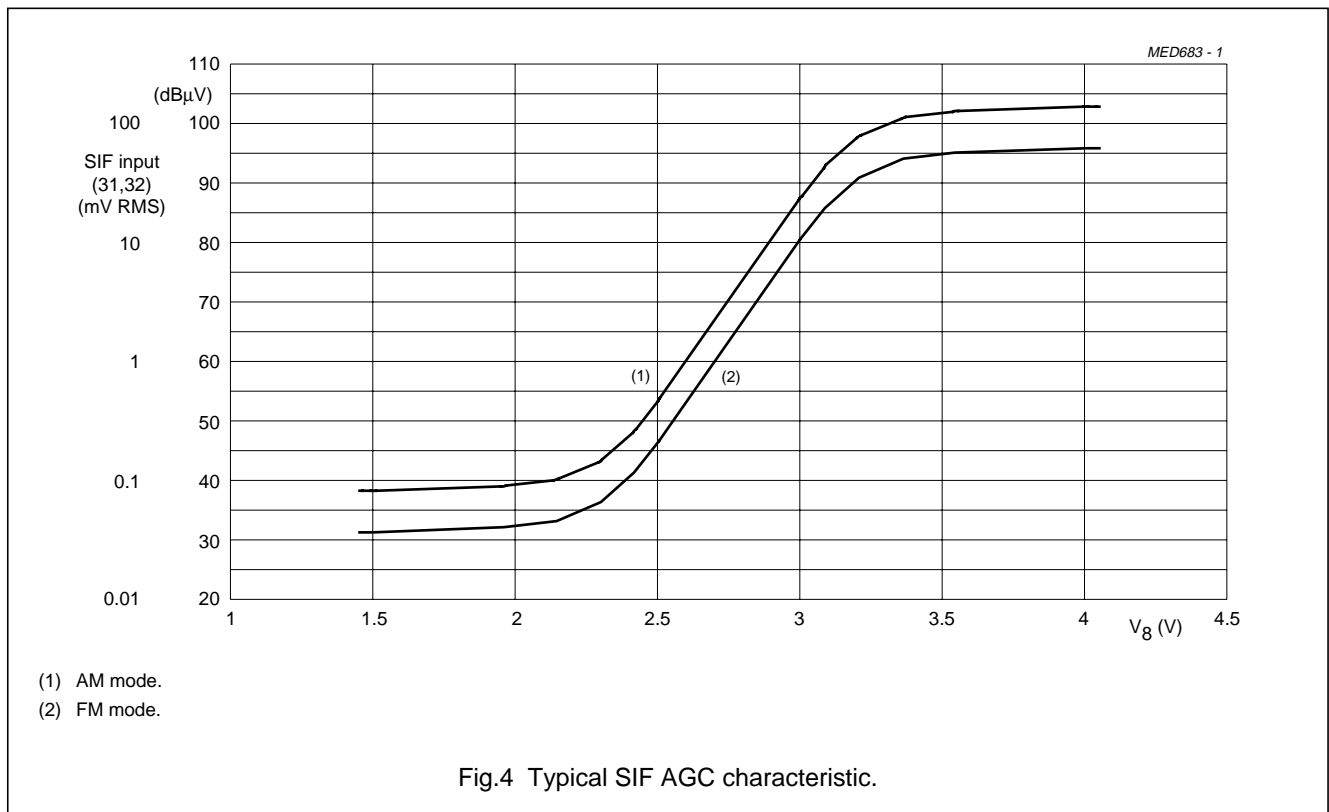
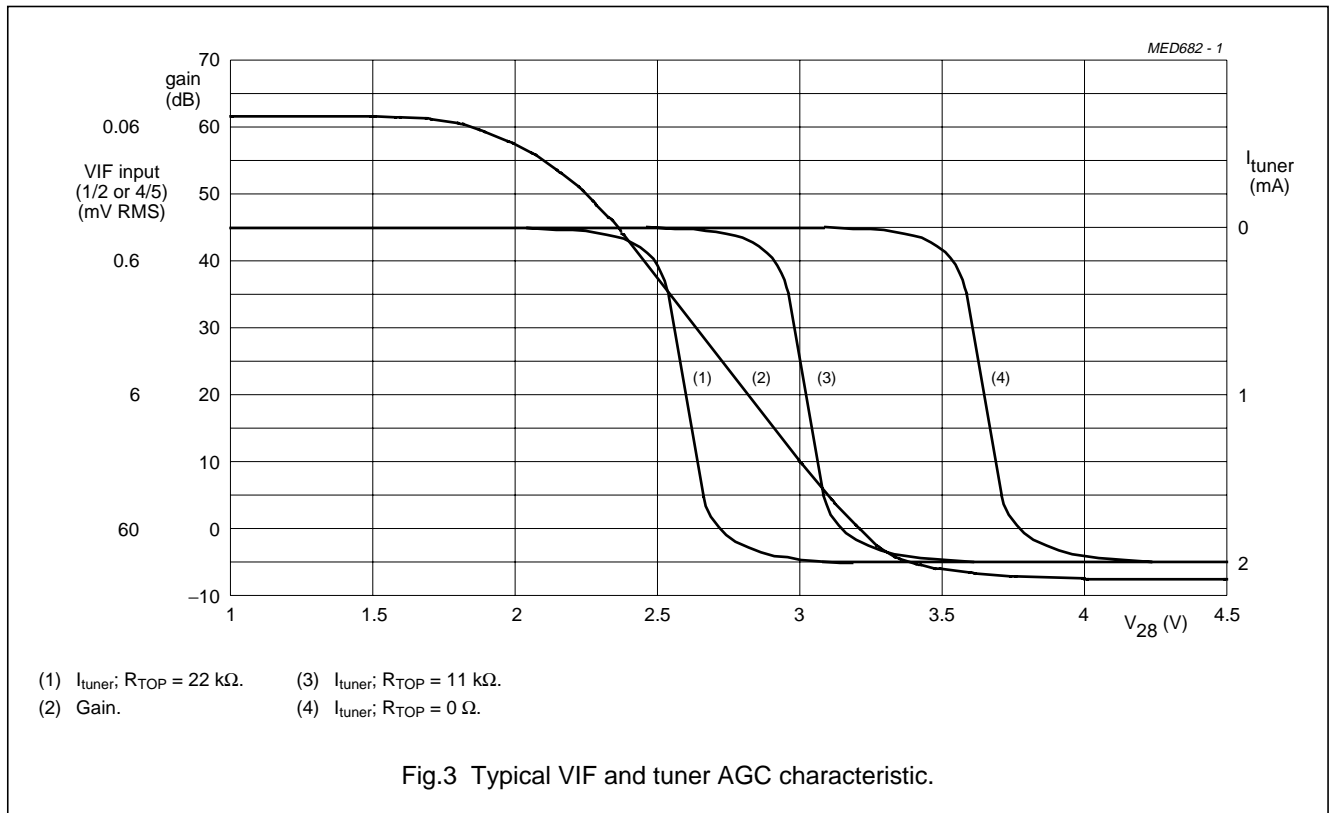

Multistandard/MAC VIF-PLL with QSS-IF  
and dual FM-PLL/AM demodulator

TDA9815

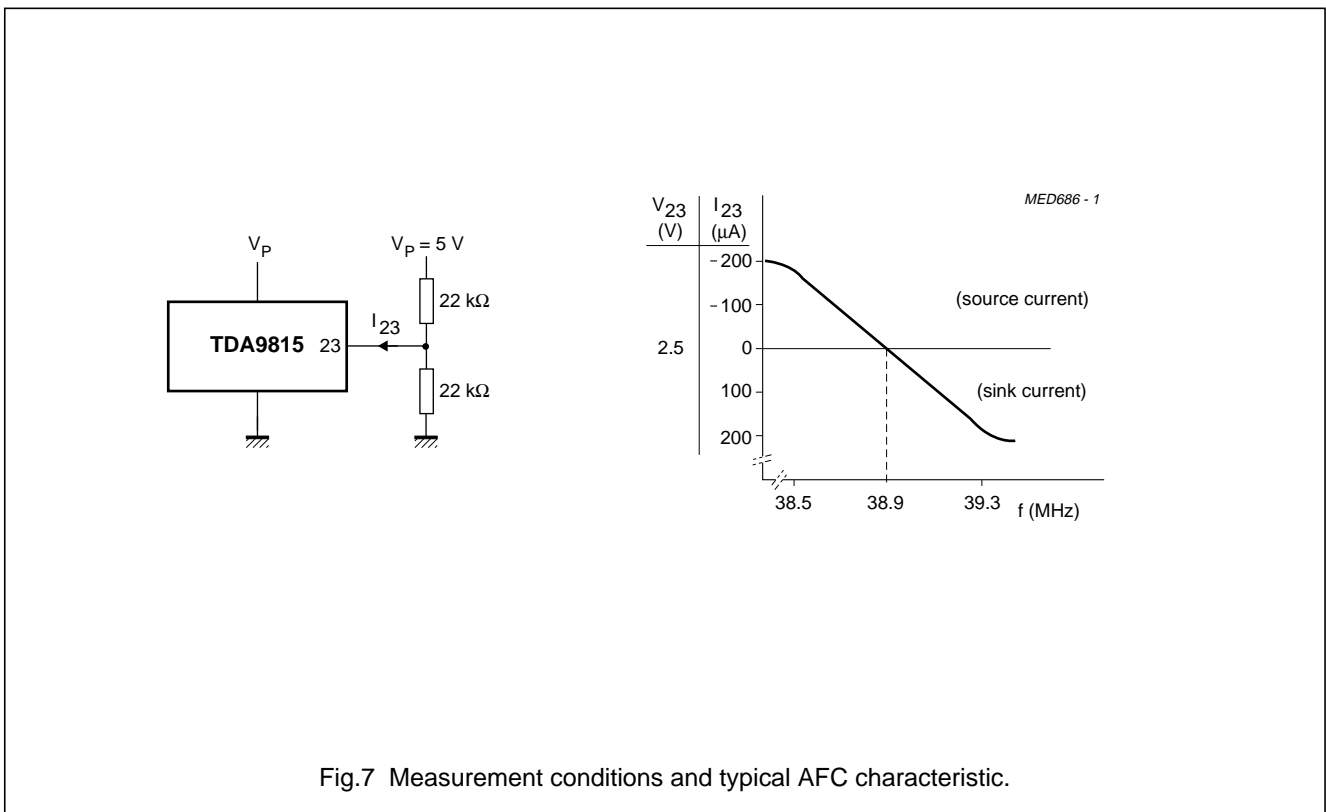
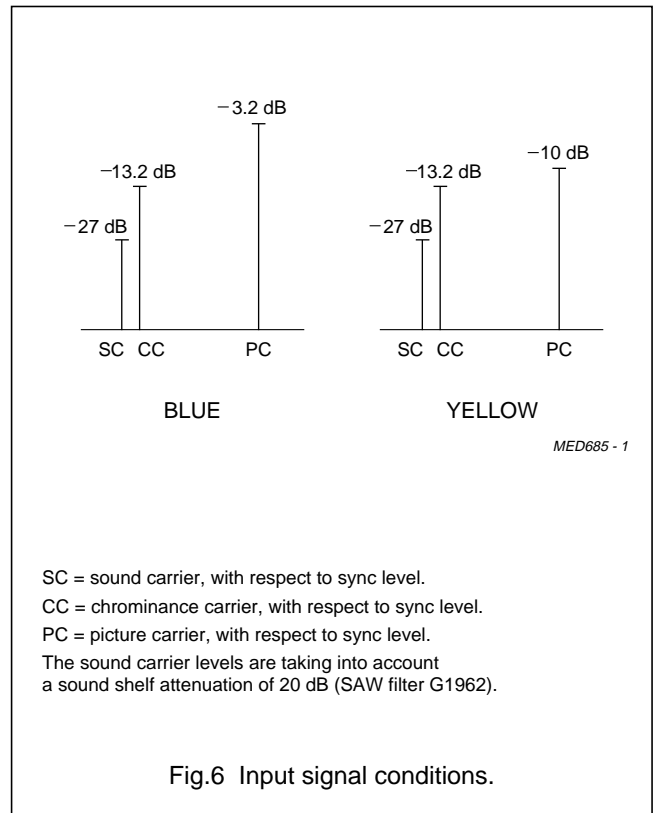
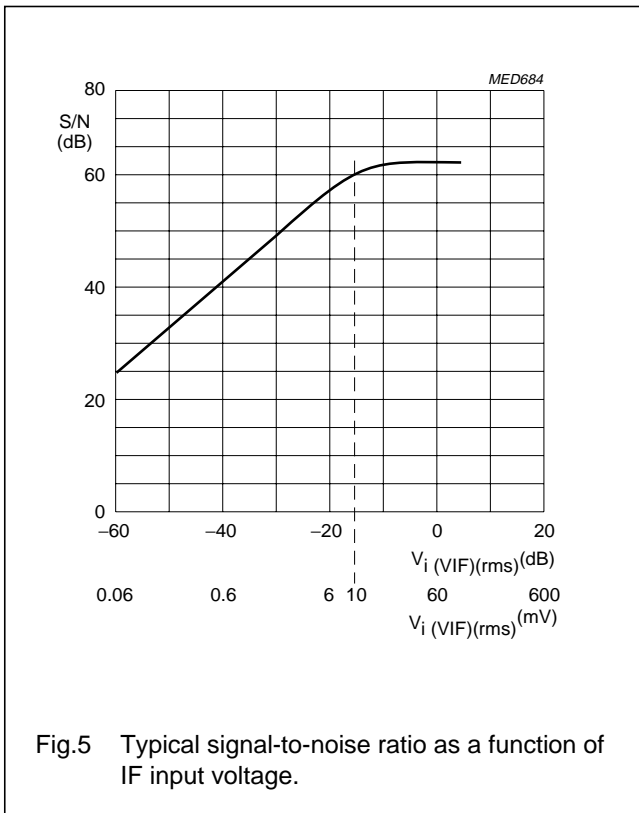

Multistandard/MAC VIF-PLL with QSS-IF  
and dual FM-PLL/AM demodulator

TDA9815

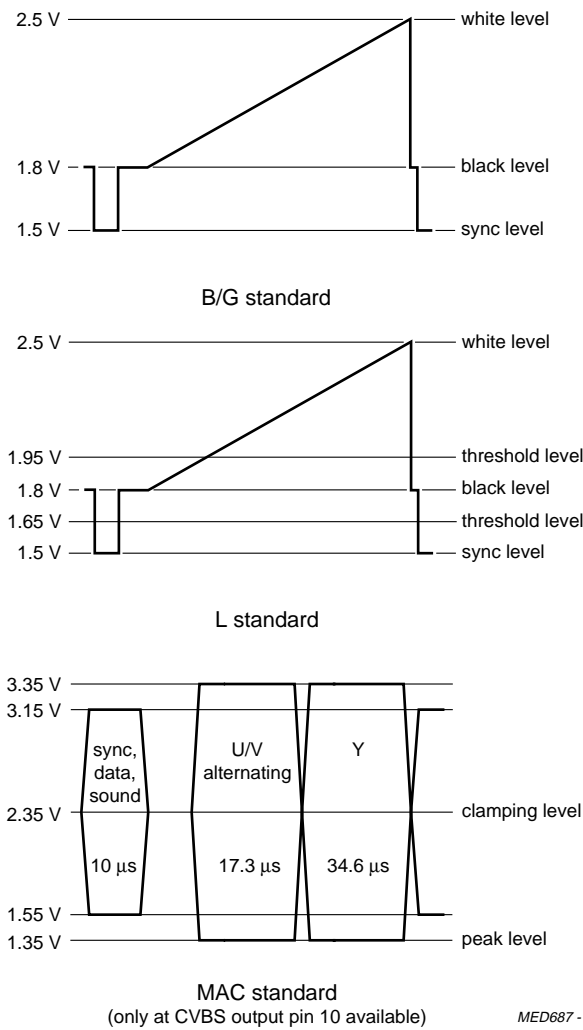
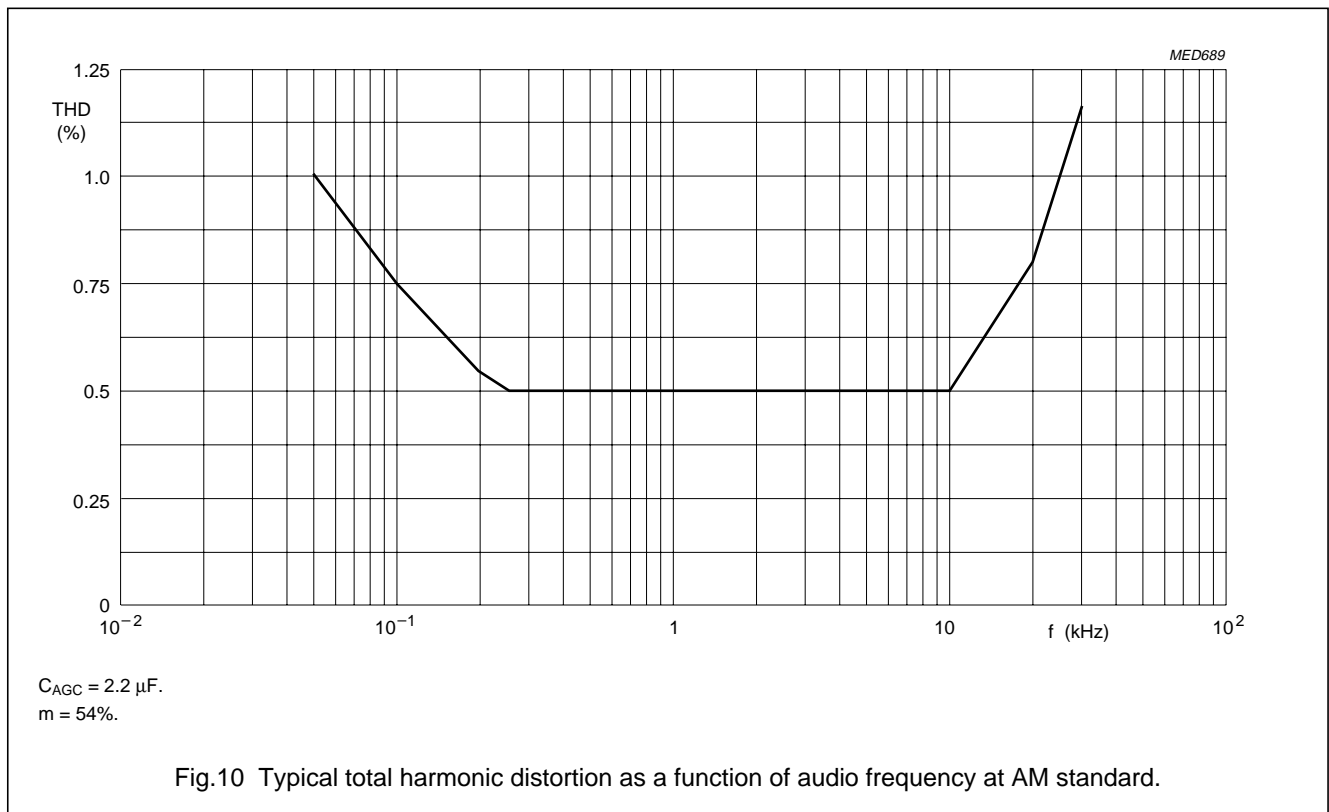
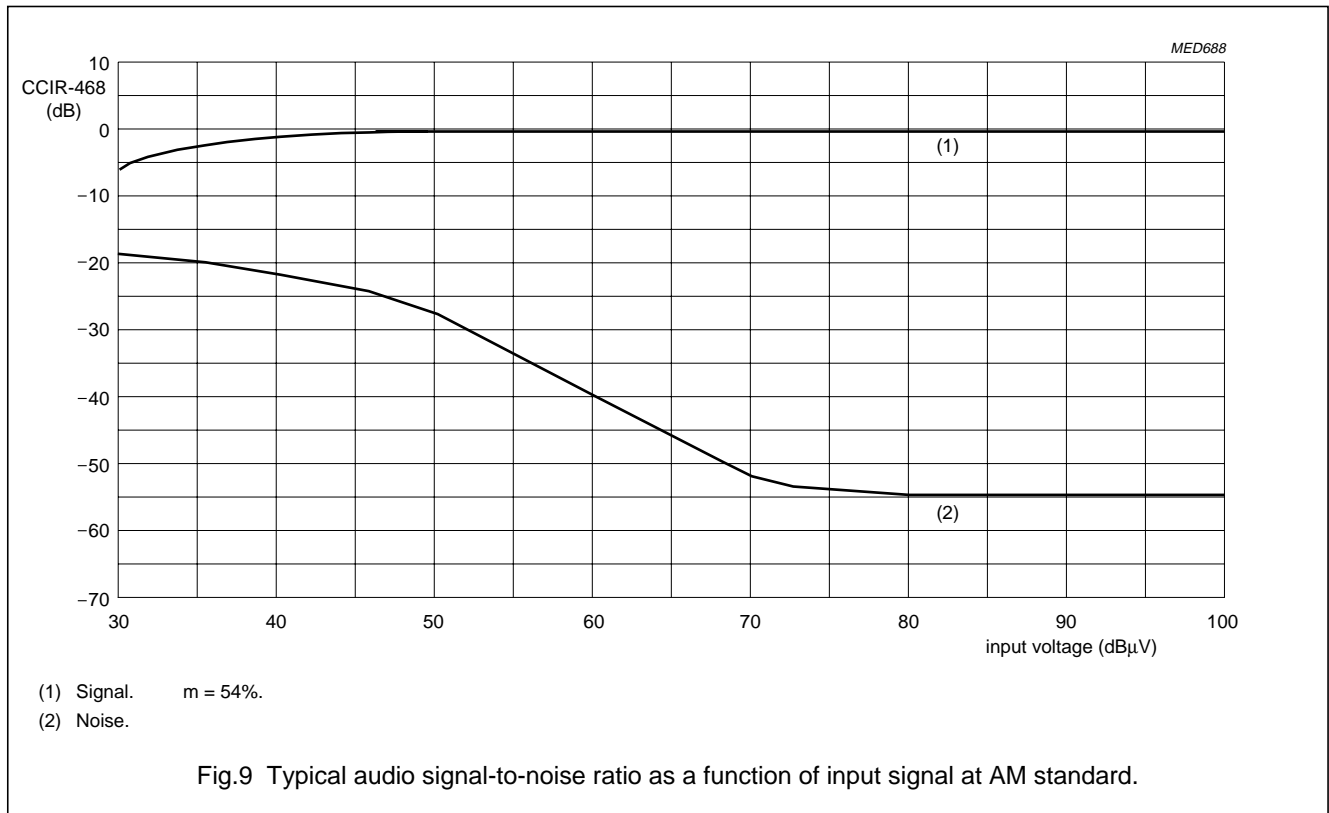

Fig.8 Typical video signal levels on output pin 21 (sound carrier **off**).

Multistandard/MAC VIF-PLL with QSS-IF  
and dual FM-PLL/AM demodulator

TDA9815



Multistandard/MAC VIF-PLL with QSS-IF  
and dual FM-PLL/AM demodulator

TDA9815

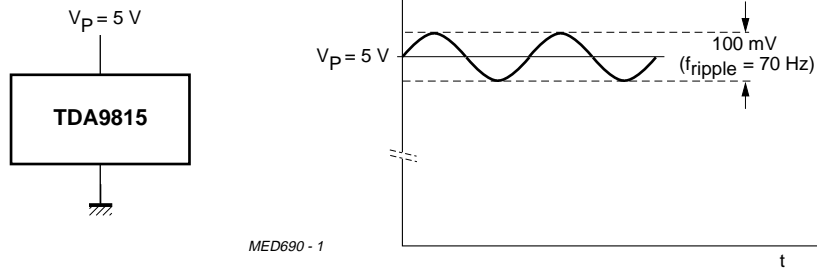
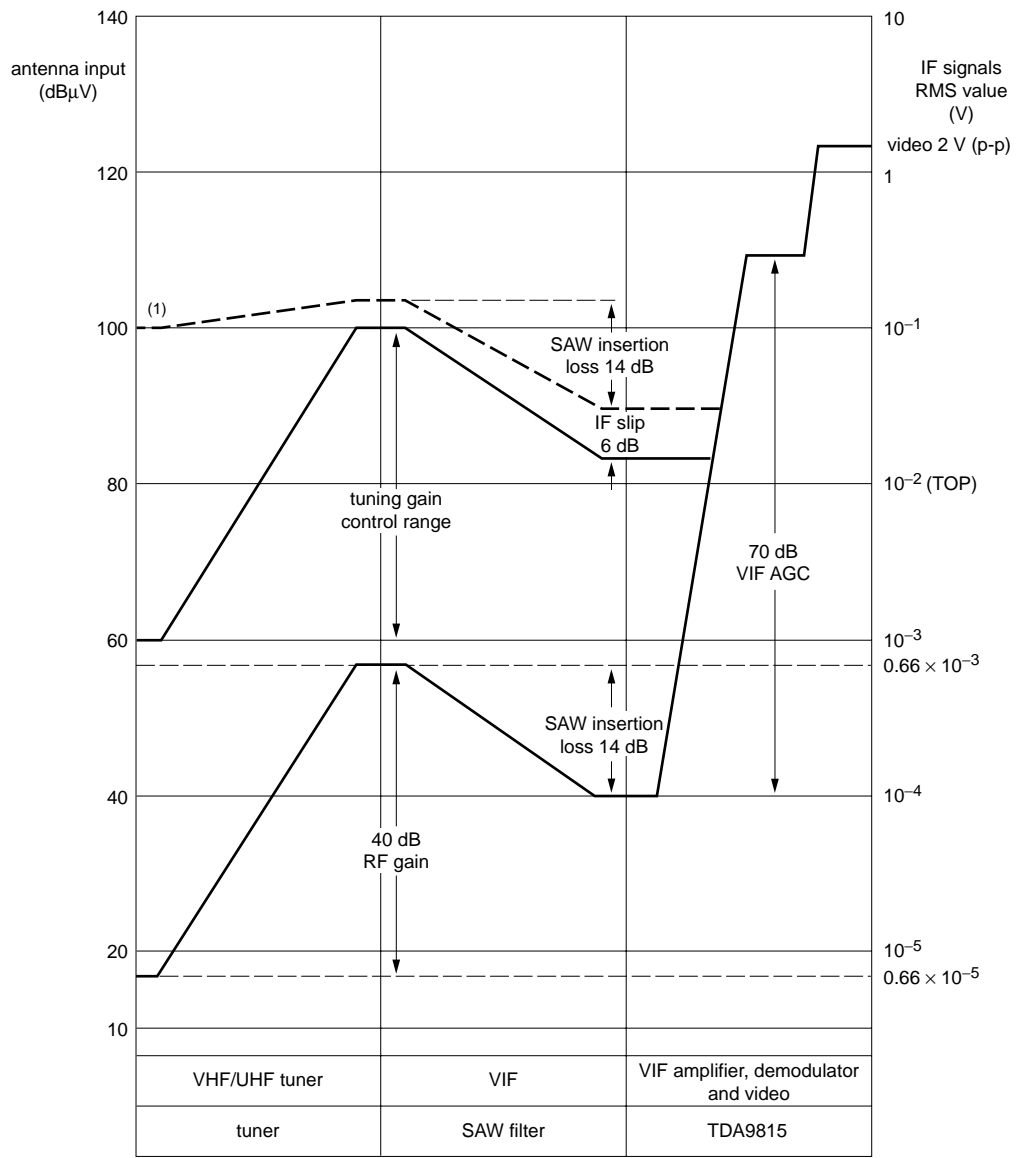

Fig.11 Ripple rejection condition.



Multistandard/MAC VIF-PLL with QSS-IF  
and dual FM-PLL/AM demodulator

TDA9815



MHA890

(1) Depends on TOP.

Fig.12 Front end level diagram.

Multistandard/MAC VIF-PLL with QSS-IF  
and dual FM-PLL/AM demodulator

TDA9815

INTERNAL CIRCUITRY

Table 3 Equivalent pin circuits and pin voltages

PIN NO.	PIN SYMBOL	DC VOLTAGE (V)	EQUIVALENT CIRCUIT (WITHOUT ESD PROTECTION CIRCUIT)
1	$V_{iVIF1}$	3.4	
2	$V_{iVIF2}$	3.4	
3	$C_{BL/MAC}$	0 to 3.2	
4	$V_{iVIF3}$	3.4	
5	$V_{iVIF4}$	3.4	

Multistandard/MAC VIF-PLL with QSS-IF  
and dual FM-PLL/AM demodulator

TDA9815

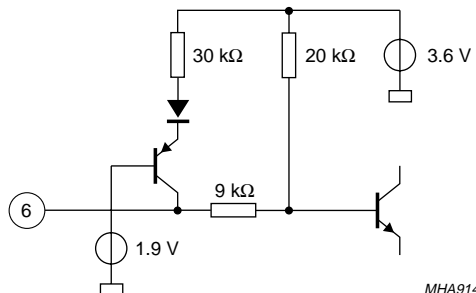
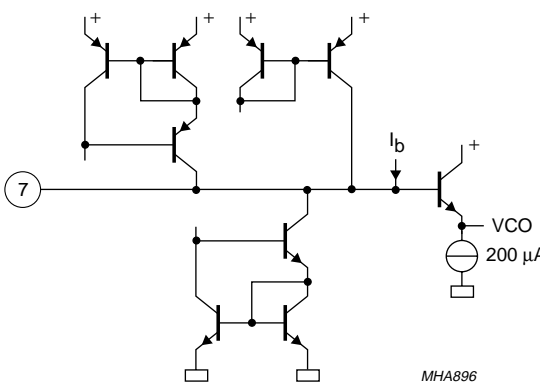
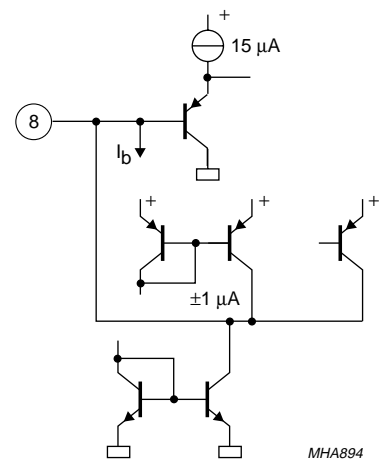
PIN NO.	PIN SYMBOL	DC VOLTAGE (V)	EQUIVALENT CIRCUIT (WITHOUT ESD PROTECTION CIRCUIT)
6	TADJ	0 to 1.9	 <p style="text-align: right;"><i>MHA914</i></p>
7	$T_{PLL}$	1.5 to 4.0	 <p style="text-align: right;"><i>MHA896</i></p>
8	CSAGC	1.5 to 4.0	 <p style="text-align: right;"><i>MHA894</i></p>

Multistandard/MAC VIF-PLL with QSS-IF  
and dual FM-PLL/AM demodulator

TDA9815

PIN NO.	PIN SYMBOL	DC VOLTAGE (V)	EQUIVALENT CIRCUIT (WITHOUT ESD PROTECTION CIRCUIT)
9	STD	0 to $V_P$	
10	$V_o$ CVBS	sync level: 1.35	
11	FMLS WI	0 to $V_P$	

Multistandard/MAC VIF-PLL with QSS-IF  
and dual FM-PLL/AM demodulator

TDA9815

PIN NO.	PIN SYMBOL	DC VOLTAGE (V)	EQUIVALENT CIRCUIT (WITHOUT ESD PROTECTION CIRCUIT)
12	$V_{OAF1}$	2.3	
13	$V_{OAF2}$	2.3	
14	$C_{DEC2}$	1.2 to 3.0	

Multistandard/MAC VIF-PLL with QSS-IF  
and dual FM-PLL/AM demodulator

TDA9815

PIN NO.	PIN SYMBOL	DC VOLTAGE (V)	EQUIVALENT CIRCUIT (WITHOUT ESD PROTECTION CIRCUIT)
15	C <sub>DEC1</sub>	1.2 to 3.0	
16	V <sub>iFM2</sub>	2.65	
17	V <sub>iFM1</sub>	2.65	
18	V <sub>iFM3</sub>	2.65	

Multistandard/MAC VIF-PLL with QSS-IF  
and dual FM-PLL/AM demodulator

TDA9815

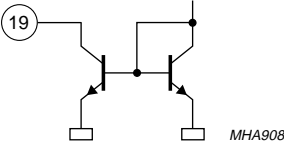
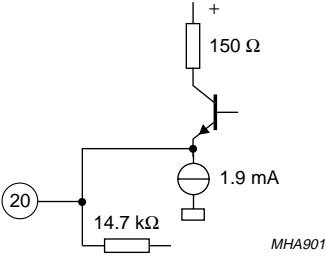
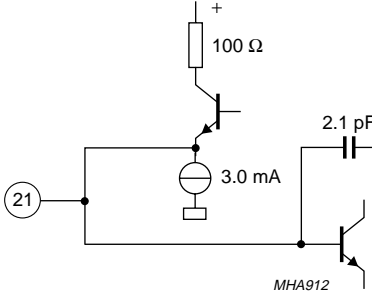
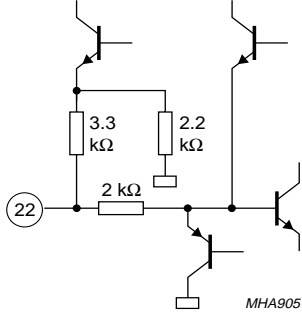
PIN NO.	PIN SYMBOL	DC VOLTAGE (V)	EQUIVALENT CIRCUIT (WITHOUT ESD PROTECTION CIRCUIT)
19	TAGC	0 to 13.2	
20	$V_{oQSS}$	2.0	
21	$V_{o(vid)}$	sync level: 1.5	
22	$V_{i(vid)}$	1.7	

Multistandard/MAC VIF-PLL with QSS-IF  
and dual FM-PLL/AM demodulator

TDA9815

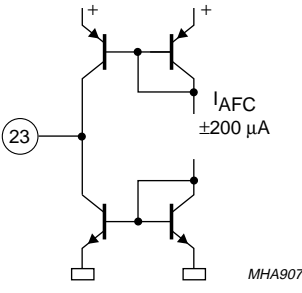
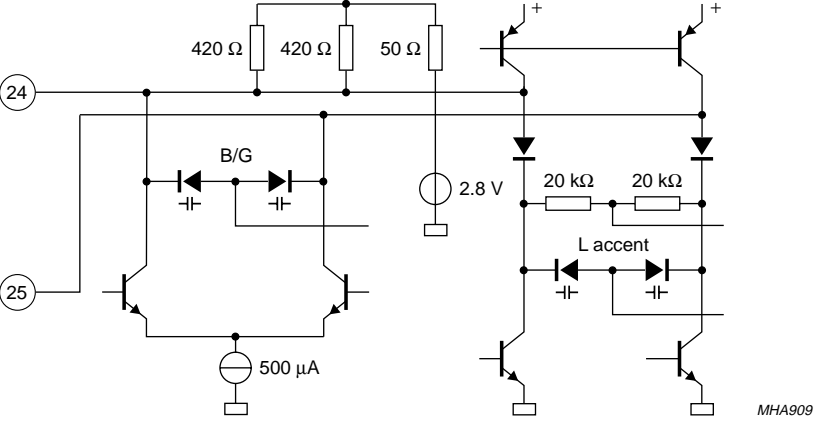
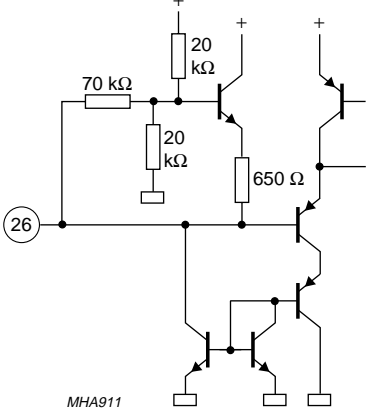
PIN NO.	PIN SYMBOL	DC VOLTAGE (V)	EQUIVALENT CIRCUIT (WITHOUT ESD PROTECTION CIRCUIT)
23	AFC	0.3 to $V_P - 0.3$	
24	VCO1	2.7	
25	VCO2	2.7	
26	$C_{ref}$	$\frac{1}{2}V_P$	
27	GND	0	



Multistandard/MAC VIF-PLL with QSS-IF  
and dual FM-PLL/AM demodulator

TDA9815

PIN NO.	PIN SYMBOL	DC VOLTAGE (V)	EQUIVALENT CIRCUIT (WITHOUT ESD PROTECTION CIRCUIT)
28	$C_{VAGC}$	1.5 to 4.0	
29	$V_P$	$V_P$	
30	IN SW1	0 to $V_P$	
31	$V_{iSIF1}$	3.4	
32	$V_{iSIF2}$	3.4	

# Multistandard/MAC VIF-PLL with QSS-IF and dual FM-PLL/AM demodulator

TDA9815

## TEST AND APPLICATION INFORMATION

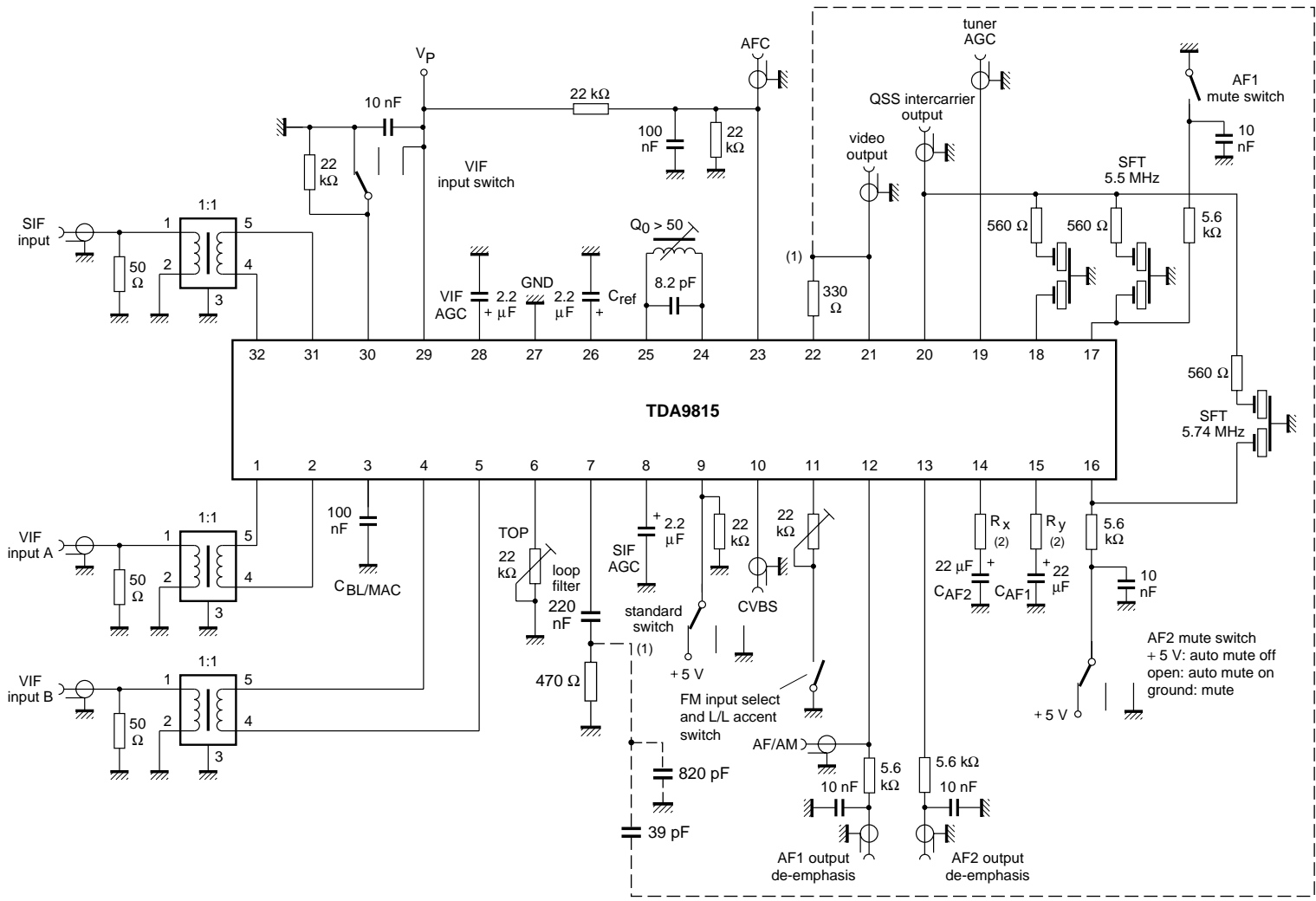

MED681 - 5

- (1) Application for improved 250 kHz sound performance.
- (2) See note 17 of Chapter "Characteristics".

Fig.13 Test circuit.

Multistandard/MAC VIF-PLL with QSS-IF  
and dual FM-PLL/AM demodulator

TDA9815

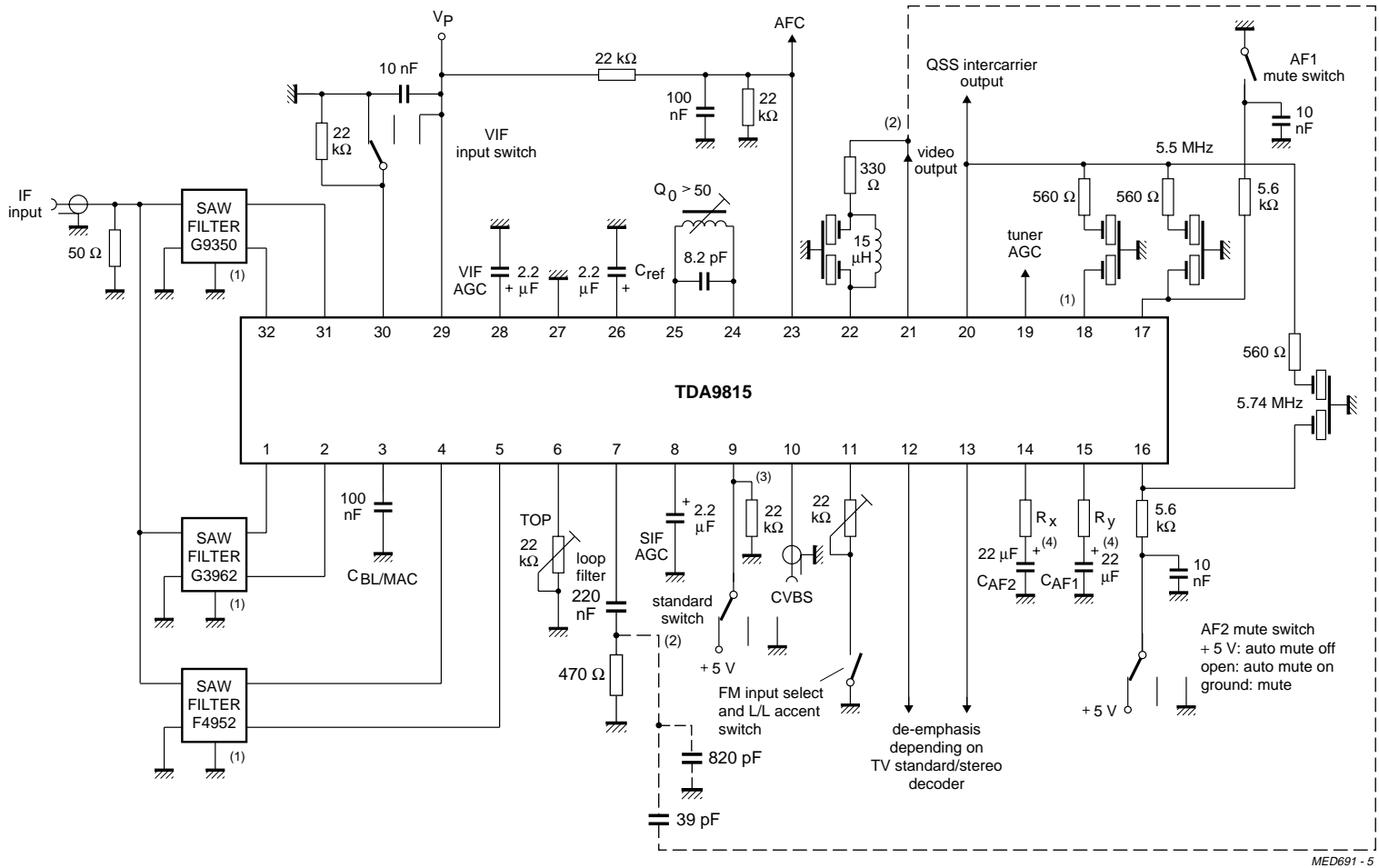

- (1) Depends on standard.
- (2) Application for improved 250 kHz sound performance.
- (3) Only required for external AGC mode.
- (4) See note 17 of Chapter "Characteristics".

Fig.14 Application circuit.

Multistandard/MAC VIF-PLL with QSS-IF  
and dual FM-PLL/AM demodulator

TDA9815

PACKAGE OUTLINE

SDIP32: plastic shrink dual in-line package; 32 leads (400 mil)

SOT232-1

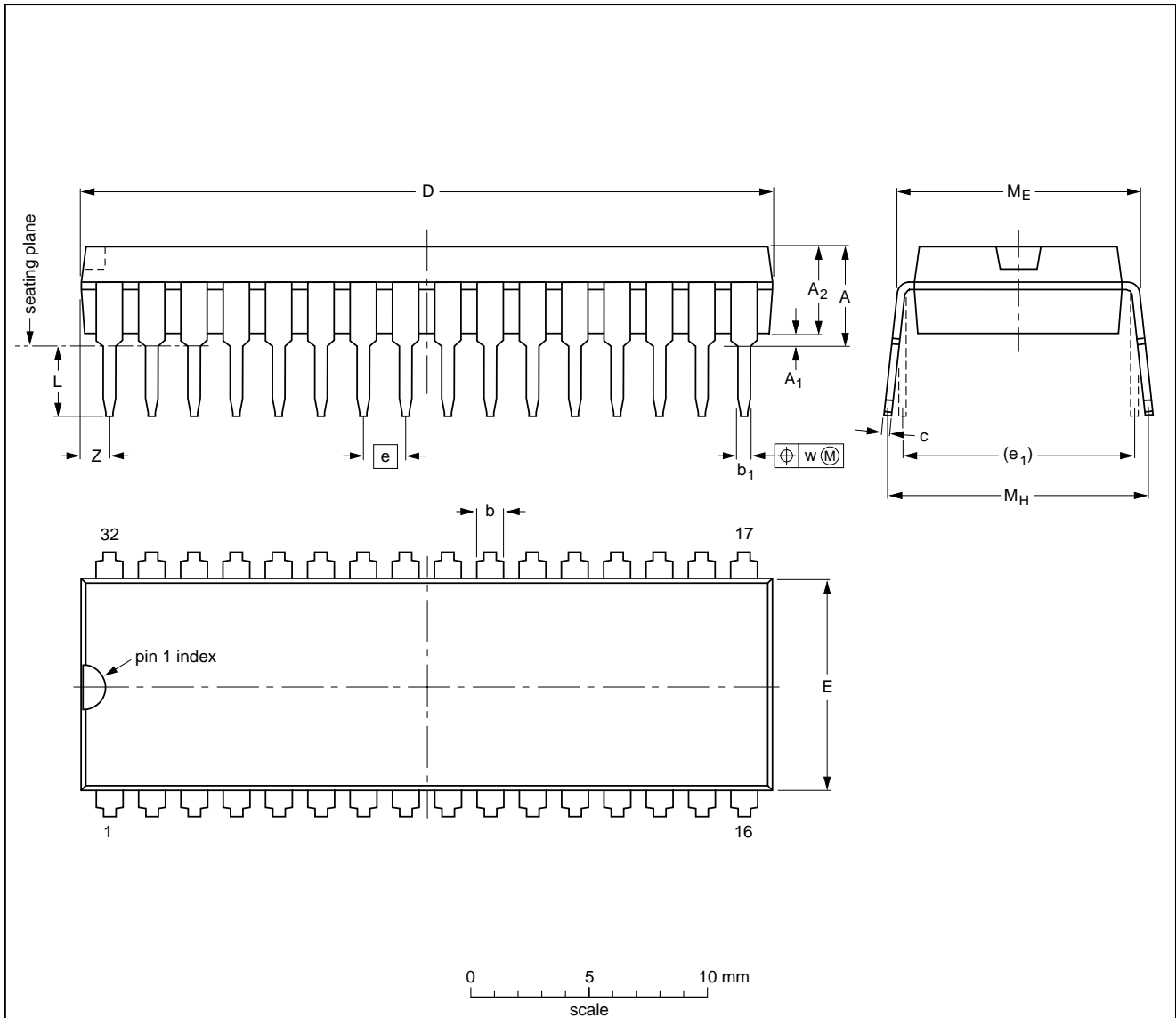

DIMENSIONS (mm are the original dimensions)

UNIT	A max.	A <sub>1</sub> min.	A <sub>2</sub> max.	b	b <sub>1</sub>	c	D <sup>(1)</sup>	E <sup>(1)</sup>	e	e <sub>1</sub>	L	M <sub>E</sub>	M <sub>H</sub>	w	Z <sup>(1)</sup> max.
mm	4.7	0.51	3.8	1.3 0.8	0.53 0.40	0.32 0.23	29.4 28.5	9.1 8.7	1.778	10.16	3.2 2.8	10.7 10.2	12.2 10.5	0.18	1.6

Note

1. Plastic or metal protrusions of 0.25 mm maximum per side are not included.

OUTLINE VERSION	REFERENCES				EUROPEAN PROJECTION	ISSUE DATE
	IEC	JEDEC	EIAJ			
SOT232-1						92-11-17 95-02-04

## Multistandard/MAC VIF-PLL with QSS-IF and dual FM-PLL/AM demodulator

TDA9815

### SOLDERING

#### Introduction

There is no soldering method that is ideal for all IC packages. Wave soldering is often preferred when through-hole and surface mounted components are mixed on one printed-circuit board. However, wave soldering is not always suitable for surface mounted ICs, or for printed-circuits with high population densities. In these situations reflow soldering is often used.

This text gives a very brief insight to a complex technology. A more in-depth account of soldering ICs can be found in our "IC Package Databook" (order code 9398 652 90011).

#### Soldering by dipping or by wave

The maximum permissible temperature of the solder is 260 °C; solder at this temperature must not be in contact with the joint for more than 5 seconds. The total contact time of successive solder waves must not exceed 5 seconds.

The device may be mounted up to the seating plane, but the temperature of the plastic body must not exceed the specified maximum storage temperature ( $T_{stg\ max}$ ). If the printed-circuit board has been pre-heated, forced cooling may be necessary immediately after soldering to keep the temperature within the permissible limit.

#### Repairing soldered joints

Apply a low voltage soldering iron (less than 24 V) to the lead(s) of the package, below the seating plane or not more than 2 mm above it. If the temperature of the soldering iron bit is less than 300 °C it may remain in contact for up to 10 seconds. If the bit temperature is between 300 and 400 °C, contact may be up to 5 seconds.

### DEFINITIONS

Data sheet status	
Objective specification	This data sheet contains target or goal specifications for product development.
Preliminary specification	This data sheet contains preliminary data; supplementary data may be published later.
Product specification	This data sheet contains final product specifications.
Limiting values	
Limiting values given are in accordance with the Absolute Maximum Rating System (IEC 134). Stress above one or more of the limiting values may cause permanent damage to the device. These are stress ratings only and operation of the device at these or at any other conditions above those given in the Characteristics sections of the specification is not implied. Exposure to limiting values for extended periods may affect device reliability.	
Application information	
Where application information is given, it is advisory and does not form part of the specification.	

### LIFE SUPPORT APPLICATIONS

These products are not designed for use in life support appliances, devices, or systems where malfunction of these products can reasonably be expected to result in personal injury. Philips customers using or selling these products for use in such applications do so at their own risk and agree to fully indemnify Philips for any damages resulting from such improper use or sale.

---

Multistandard/MAC VIF-PLL with QSS-IF  
and dual FM-PLL/AM demodulator

---

TDA9815

NOTES

---

Multistandard/MAC VIF-PLL with QSS-IF  
and dual FM-PLL/AM demodulator

---

TDA9815

NOTES

# Philips Semiconductors – a worldwide company

**Argentina:** see South America

**Australia:** 34 Waterloo Road, NORTH RYDE, NSW 2113,  
Tel. +61 2 9805 4455, Fax. +61 2 9805 4466

**Austria:** Computerstr. 6, A-1101 WIEN, P.O. Box 213, Tel. +43 160 1010,  
Fax. +43 160 101 1210

**Belarus:** Hotel Minsk Business Center, Bld. 3, r. 1211, Volodarski Str. 6,  
220050 MINSK, Tel. +375 172 200 733, Fax. +375 172 200 773

**Belgium:** see The Netherlands

**Brazil:** see South America

**Bulgaria:** Philips Bulgaria Ltd., Energoproject, 15th floor,  
51 James Bourchier Blvd., 1407 SOFIA,  
Tel. +359 2 689 211, Fax. +359 2 689 102

**Canada:** PHILIPS SEMICONDUCTORS/COMPONENTS,  
Tel. +1 800 234 7381

**China/Hong Kong:** 501 Hong Kong Industrial Technology Centre,  
72 Tat Chee Avenue, Kowloon Tong, HONG KONG,  
Tel. +852 2319 7888, Fax. +852 2319 7700

**Colombia:** see South America

**Czech Republic:** see Austria

**Denmark:** Prags Boulevard 80, PB 1919, DK-2300 COPENHAGEN S,  
Tel. +45 32 88 2636, Fax. +45 31 57 0044

**Finland:** Sinikalliontie 3, FIN-02630 ESPOO,  
Tel. +358 9 615800, Fax. +358 9 61580920

**France:** 51 Rue Carnot, BP317, 92156 SURESNES Cedex,  
Tel. +33 1 40 99 6161, Fax. +33 1 40 99 6427

**Germany:** Hammerbrookstraße 69, D-20097 HAMBURG,  
Tel. +49 40 23 53 60, Fax. +49 40 23 536 300

**Greece:** No. 15, 25th March Street, GR 17778 TAVROS/ATHENS,  
Tel. +30 1 4894 339/239, Fax. +30 1 4814 240

**Hungary:** see Austria

**India:** Philips INDIA Ltd, Band Box Building, 2nd floor,  
254-D, Dr. Annie Besant Road, Worli, MUMBAI 400 025,  
Tel. +91 22 493 8541, Fax. +91 22 493 0966

**Indonesia:** see Singapore

**Ireland:** Newstead, Clonskeagh, DUBLIN 14,  
Tel. +353 1 7640 000, Fax. +353 1 7640 200

**Israel:** RAPAC Electronics, 7 Kehilat Saloniki St, PO Box 18053,  
TEL AVIV 61180, Tel. +972 3 645 0444, Fax. +972 3 649 1007

**Italy:** PHILIPS SEMICONDUCTORS, Piazza IV Novembre 3,  
20124 MILANO, Tel. +39 2 6752 2531, Fax. +39 2 6752 2557

**Japan:** Philips Bldg 13-37, Kohnan 2-chome, Minato-ku, TOKYO 108,  
Tel. +81 3 3740 5130, Fax. +81 3 3740 5077

**Korea:** Philips House, 260-199 Itaewon-dong, Yongsan-ku, SEOUL,  
Tel. +82 2 709 1412, Fax. +82 2 709 1415

**Malaysia:** No. 76 Jalan Universiti, 46200 PETALING JAYA, SELANGOR,  
Tel. +60 3 750 5214, Fax. +60 3 757 4880

**Mexico:** 5900 Gateway East, Suite 200, EL PASO, TEXAS 79905,  
Tel. +9-5 800 234 7381

**Middle East:** see Italy

**Netherlands:** Postbus 90050, 5600 PB EINDHOVEN, Bldg. VB,  
Tel. +31 40 27 82785, Fax. +31 40 27 88399

**New Zealand:** 2 Wagener Place, C.P.O. Box 1041, AUCKLAND,  
Tel. +64 9 849 4160, Fax. +64 9 849 7811

**Norway:** Box 1, Manglerud 0612, OSLO,  
Tel. +47 22 74 8000, Fax. +47 22 74 8341

**Philippines:** Philips Semiconductors Philippines Inc.,  
106 Valero St. Salcedo Village, P.O. Box 2108 MCC, MAKATI,  
Metro MANILA, Tel. +63 2 816 6380, Fax. +63 2 817 3474

**Poland:** Ul. Lukiska 10, PL 04-123 WARSZAWA,  
Tel. +48 22 612 2831, Fax. +48 22 612 2327

**Portugal:** see Spain

**Romania:** see Italy

**Russia:** Philips Russia, Ul. Usatcheva 35A, 119048 MOSCOW,  
Tel. +7 095 755 6918, Fax. +7 095 755 6919

**Singapore:** Lorong 1, Toa Payoh, SINGAPORE 1231,  
Tel. +65 350 2538, Fax. +65 251 6500

**Slovakia:** see Austria

**Slovenia:** see Italy

**South Africa:** S.A. PHILIPS Pty Ltd., 195-215 Main Road Martindale,  
2092 JOHANNESBURG, P.O. Box 7430 Johannesburg 2000,  
Tel. +27 11 470 5911, Fax. +27 11 470 5494

**South America:** Al. Vicente Pinzon, 173, 6th floor,  
04547-130 SÃO PAULO, SP, Brazil,  
Tel. +55 11 821 2333, Fax. +55 11 821 2382

**Spain:** Balmes 22, 08007 BARCELONA,  
Tel. +34 3 301 6312, Fax. +34 3 301 4107

**Sweden:** Kottbygatan 7, Akalla, S-16485 STOCKHOLM,  
Tel. +46 8 632 2000, Fax. +46 8 632 2745

**Switzerland:** Allmendstrasse 140, CH-8027 ZÜRICH,  
Tel. +41 1 488 2686, Fax. +41 1 488 3263

**Taiwan:** Philips Semiconductors, 6F, No. 96, Chien Kuo N. Rd., Sec. 1,  
TAIPEI, Taiwan Tel. +886 2 2134 2865, Fax. +886 2 2134 2874

**Thailand:** PHILIPS ELECTRONICS (THAILAND) Ltd.,  
209/2 Sanpavuth-Bangna Road Prakanong, BANGKOK 10260,  
Tel. +66 2 745 4090, Fax. +66 2 398 0793

**Turkey:** Talatpasa Cad. No. 5, 80640 GÜLTEPE/ISTANBUL,  
Tel. +90 212 279 2770, Fax. +90 212 282 6707

**Ukraine:** PHILIPS UKRAINE, 4 Patrice Lumumba str., Building B, Floor 7,  
252042 KIEV, Tel. +380 44 264 2776, Fax. +380 44 268 0461

**United Kingdom:** Philips Semiconductors Ltd., 276 Bath Road, Hayes,  
MIDDLESEX UB3 5BX, Tel. +44 181 730 5000, Fax. +44 181 754 8421

**United States:** 811 East Arques Avenue, SUNNYVALE, CA 94088-3409,  
Tel. +1 800 234 7381

**Uruguay:** see South America

**Vietnam:** see Singapore

**Yugoslavia:** PHILIPS, Trg N. Pasica 5/v, 11000 BEOGRAD,  
Tel. +381 11 625 344, Fax. +381 11 635 777

**For all other countries apply to:** Philips Semiconductors,  
International Marketing & Sales Communications, Building BE-p, P.O. Box 218,  
5600 MD EINDHOVEN, The Netherlands, Fax. +31 40 27 24825

**Internet:** <http://www.semiconductors.philips.com>

© Philips Electronics N.V. 1998

SCA57

All rights are reserved. Reproduction in whole or in part is prohibited without the prior written consent of the copyright owner.

The information presented in this document does not form part of any quotation or contract, is believed to be accurate and reliable and may be changed without notice. No liability will be accepted by the publisher for any consequence of its use. Publication thereof does not convey nor imply any license under patent- or other industrial or intellectual property rights.

Printed in The Netherlands

545104/1200/04/pp40

Date of release: 1998 Feb 11

Document order number: 9397 750 03002

*Let's make things better.*

**Philips  
Semiconductors**



**PHILIPS**